

## **Operating instructions**

### **LAUDA Proline cooling thermostats**





## Operating instructions

### PROLINE

Cooling thermostats  
with SmartCool System

RP 845 (C), RP 855 (C), RP 870 (C), RP 890 (C), RP 1290 (C),  
RP 1840 (C), RP 1845 (C), RP 3530 (C)

english translation of the original operating instructions  
version 08/2016  
replaces versions 03/08, 08/07, 08/06, 01/05  
YACE0072

from softwareversion of Control system (Master) 3.22  
from softwareversion of Protection system (Master) 2.08  
from softwareversion of Operating system (Command) 2.03  
from softwareversion of Cooling system 2.03  
from softwareversion of Analogue interface 3.10  
from softwareversion of RS232/485-Module 3.11  
from softwareversion of contact I/O module 3.11  
from softwareversion of solenoid valve 3.00

LAUDA DR. R. WOBSE GMBH & CO. KG  
Pfarstraße 41/43  
97922 Lauda-Königshofen  
Germany

Phone: +49 (0)9343 503-0  
Fax: +49 (0)9343 503-222  
E-Mail [info@lauda.de](mailto:info@lauda.de)  
Internet <http://www.lauda.de>



## Prefixed safety notes

Before operating the equipment, please read carefully all the instructions and safety notes in Section 1.

If you have any questions, please phone us!

Follow the instructions on setting up, operation etc. This is the only way to avoid incorrect operation of the equipment and to ensure full warranty protection.

- Transport the equipment with care!  
The unit may NEVER be overturned nor put upside down!
- Equipment and its internal parts can be damaged:
  - by dropping,
  - by shock.
- Technically qualified personnel must only operate the equipment!
- Never operate the equipment without the heat transfer liquid!
- Do not start up the equipment if:
  - it is damaged or leaking,
  - cable (not only supply cable) is damaged.
- Switch off the equipment and pull out the mains plug:
  - for servicing or repair,
  - moving the equipment
- Drain the bath before moving the equipment!
- Do not carry out any technical changes on the device!
- Have the equipment serviced or repaired by properly qualified personnel only!

**The Operating Instructions include additional safety notes, which are identified by a triangle with an exclamation mark. Carefully read the instructions and follow them accurately! Disregarding the instructions may have serious consequences, such as damage to the equipment, damage to property or injury to personnel!**

We reserve the right to make technical alterations!

### Contents

<b>1</b>	<b>SAFETY INFORMATION .....</b>	<b>8</b>
1.1	GENERAL SAFETY INFORMATION .....	8
1.2	OTHER SAFETY INFORMATION .....	9
1.3	EU CONFORMITY .....	9
<b>2</b>	<b>BRIEF OPERATING INSTRUCTIONS .....</b>	<b>10</b>
2.1	MENU STRUCTURE: MASTER .....	11
2.2	MENU STRUCTURE: COMMAND .....	12
<b>3</b>	<b>CONTROLS AND FUNCTIONAL ELEMENTS .....</b>	<b>13</b>
<b>4</b>	<b>UNIT DESCRIPTION.....</b>	<b>16</b>
4.1	ENVIRONMENTAL CONDITIONS .....	16
4.2	TYPES OF UNIT .....	16
4.3	VARIOFLEX PUMP.....	16
4.4	MATERIALS.....	17
4.5	TEMPERATURE DISPLAY, CONTROL AND SAFETY CIRCUIT.....	17
4.6	PROGRAMMER AND RAMP FUNCTION .....	18
4.7	INTERFACES .....	18
4.8	INTERFACE MODULES (ACCESSORIES).....	18
4.9	COOLING UNIT .....	19
4.10	AVOIDANCE OF DEWING .....	19
4.11	HEATER RATING AND POWER CONSUMPTION FROM THE MAINS.....	19
<b>5</b>	<b>UNPACKING .....</b>	<b>20</b>
<b>6</b>	<b>PREPARATION .....</b>	<b>21</b>
6.1	ASSEMBLY AND SITING .....	21
6.2	FILLING AND DRAINING .....	22
6.3	HEAT TRANSFER LIQUIDS AND HOSES.....	23
6.4	CONNECTING EXTERNAL LOADS.....	25
<b>7</b>	<b>STARTING UP .....</b>	<b>26</b>
7.1	MAINS CONNECTION.....	26
7.2	SWITCHING ON .....	26
7.3	SWITCHING OFF / STANDBY.....	28
7.4	KEY FUNCTIONS.....	28
7.4.1	<i>General key functions and pilot lamps.....</i>	<i>28</i>
7.4.2	<i>Changing window information (Command Console) .....</i>	<i>32</i>
7.4.3	<i>Locking the keyboard.....</i>	<i>33</i>
7.5	"MASTER" MENU STRUCTURE .....	35
7.6	"COMMAND" MENU STRUCTURE .....	36
7.6.1	<i>Basic settings and branching to submenus (Master).....</i>	<i>37</i>
7.6.2	<i>Submenu PPEru (Master): Branching to further submenus.....</i>	<i>38</i>
7.6.3	<i>Submenu PPadu (Master): Configuration of modules.....</i>	<i>39</i>
7.6.4	<i>Submenu PPEru → PPRP . (Master): Configuration of device parameters .....</i>	<i>40</i>
7.6.5	<i>Submenu PPEru → P id . . (Master): Setting internal control parameters.....</i>	<i>41</i>
7.6.6	<i>Submenu PPEru → P id . . (Master): Setting external control parameters .....</i>	<i>42</i>
7.6.7	<i>Submenu PPEru → CAL . . (Master): Calibrating internal and external Pt100 temperature probe measuring chains (adjustment) .....</i>	<i>44</i>
7.6.8	<i>Submenu PPEru → Show (Master): Displaying internal values of the thermostat.....</i>	<i>45</i>
7.6.9	<i>Submenu PPadu → SEC . . (Master): Safety system settings.....</i>	<i>48</i>
7.6.10	<i>Submenu PPadu → COOL . . (Master): Refrigerating system settings .....</i>	<i>49</i>
7.6.11	<i>Submenu PPadu → COOL . . → Show (Master): Displaying refrigerating system settings .....</i>	<i>50</i>

7.6.12	Submenu <i>Produ</i> → <i>COOL</i> → <i>SEr</i> .. (Master): Displaying refrigerating system settings .....	52
7.7	IMPORTANT SETTINGS .....	53
7.7.1	Temperature setpoint setting .....	53
7.7.2	Displaying the actual external temperature .....	55
7.7.3	Setting pump power or standby .....	56
7.7.4	Activating external control .....	57
7.7.5	Current consumption from the mains .....	58
7.7.6	Setting the date and time (Command) .....	60
7.7.7	Display resolution setting (Command) .....	60
7.8	SPECIAL SETTINGS .....	61
7.8.1	Setpoint resolution .....	61
7.8.2	Defining the type of start mode .....	61
7.8.3	Defining temperature limits .....	63
7.8.4	Setpoint offset operating mode .....	64
7.8.5	Restoring works settings .....	66
7.8.6	Setting the volume of the acoustic signals .....	68
7.8.7	Entering the offset of the internal temperature probe .....	69
7.8.8	Restoring the works setting of the internal temperature-probe offset .....	70
7.8.9	Entering the offset of the external temperature probe .....	71
7.8.10	Restoring the works setting of the external temperature-probe offset .....	72
7.9	GRAPHICAL DISPLAY OF TEMPERATURE MEASUREMENTS (COMMAND) .....	73
7.10	PROGRAMMER (PGM ONLY COMMAND) .....	75
7.10.1	Program example .....	75
7.10.2	Selecting and starting the program (Start, Hold, Stop) .....	77
7.10.3	Interrupting, continuing or terminating the program (Hold, Continue, Stop) .....	78
7.10.4	Creating or modifying a program (Edit) .....	79
7.10.5	Defining the number of program loops (Loops) .....	83
7.10.6	Viewing the program sequence as a graph (Graph) .....	83
7.10.7	Obtaining information on a program (Info) .....	84
7.11	RAMP FUNCTION .....	85
7.12	TIMER FUNCTION (COMMAND) .....	86
7.13	CONTROL PARAMETERS .....	87
7.13.1	Internal control variable (integral measurement probe) .....	88
7.13.2	External control variable (External measurement probe) .....	89
7.13.3	Internal and external control parameter sets .....	93
7.13.4	Self Adaption (only COMMAND) .....	94
7.14	ALARMS, WARNINGS AND ERRORS .....	96
7.14.1	Overtemperature protection and checking .....	96
7.14.2	Low-level alarm and low-level checking .....	98
7.14.3	High-level settings .....	99
7.14.4	High-level warning or alarm .....	100
7.14.5	Pump-motor supervision: Overload or blockage .....	101
7.14.6	Pump-motor supervision: Dry running .....	101
7.14.7	Fault list „Alarms and Warnings“ .....	102
<b>8</b>	<b>INTERFACES - MODULES .....</b>	<b>105</b>
8.1	INSTALLING OF MODULES .....	105
8.2	MENU STRUCTURE FOR ALL MODULES (ONLY COMMAND) .....	106
8.3	SERIAL INTERFACES RS232/485 .....	107
8.3.1	Menu structure for RS232/485 Interface Module (Master) .....	107
8.3.2	Connecting cables and interface test RS232 .....	108
8.3.3	Protocol RS232 .....	108
8.3.4	Connecting cable RS485 .....	109
8.3.5	Protocol RS485 .....	109
8.3.6	Write commands (Data commands to the thermostat) .....	110
8.3.7	Read commands (Data requested from the thermostat) .....	111
8.3.8	Error messages .....	113
8.3.9	Driver software for LABVIEW® .....	113

8.4	ANALOGUE MODULE .....	114
8.4.1	<i>Menu structure Analogue module (Master)</i> .....	116
8.5	CONTACT MODULE .....	117
8.5.1	<i>Contact module LRZ 915 with three inputs and three outputs</i> .....	117
8.5.2	<i>Namur-Contact module LRZ 914 with only one input and one output</i> .....	118
8.5.3	<i>Menu structure contact module (Master)</i> .....	119
<b>9</b>	<b>MAINTENANCE .....</b>	<b>120</b>
9.1	CLEANING .....	120
9.2	DEVICE STATUS .....	120
9.2.1	<i>Interrogating the device type</i> .....	120
9.2.2	<i>Software version</i> .....	120
9.2.3	<i>Serial numbers</i> .....	120
9.2.4	<i>Device data</i> .....	121
9.2.5	<i>Fault memory (Command)</i> .....	121
9.3	SERVICING REPAIR AND DISPOSAL INFORMATION .....	122
9.3.1	<i>Servicing</i> .....	122
9.3.2	<i>Service intervals</i> .....	123
9.3.3	<i>Cleanig the condenser</i> .....	123
9.3.4	<i>Testing the heat transfer liquid</i> .....	123
9.3.5	<i>Repair information</i> .....	123
9.3.6	<i>Disposal information</i> .....	124
9.3.7	<i>Disposal of the refrigerant</i> .....	124
9.3.8	<i>Disposal of the packaging</i> .....	124
9.4	SERVICE, ORDERING REPLACEMENT PARTS AND RATING LABEL .....	125
<b>10</b>	<b>ACCESSORIES .....</b>	<b>126</b>
<b>11</b>	<b>TECHNICAL DATA AND DIAGRAMS.....</b>	<b>128</b>
<b>12</b>	<b>INDEX .....</b>	<b>132</b>



**Explanation of signs:**



Caution: This sign is used where there may be injury to personnel if a recommendation is not followed accurately or is disregarded.



Note: Here special attention is drawn to some aspect. May include reference to danger.



Reference Refers to other information in different sections.

## 1 Safety information

### 1.1 General safety information

A laboratory thermostat heats, cools and circulates liquids according to specified parameters. This involves hazards due to high or low temperatures, fire and general hazards due to the application of electrical energy.

The user is largely protected by the application of relevant standards.

Further hazard sources may arise due to the type of tempering medium, e.g. by exceeding or undercutting certain temperature thresholds or by the breakage of the container and reaction with the heat transfer liquid.

It is not possible to consider all eventualities. They remain largely subject to the judgment and responsibility of the operator.

The equipment may only be used as prescribed and as described in these operating instructions. This includes operation by instructed specialist personnel.

The equipment is not rated for use under medical conditions according to DIN EN 60601-1 or IEC 601-1.

The equipment fulfills the following classes of the EMC standard EN 61326-1:1997 VDE 0843-20:

Class A: Operation only on networks without connected domestic areas.

Class B: Equipment for operation on networks with connected domestic areas.

Class B\*: Equipment fulfills Class B when a house connection > 100 A is involved. With unfavorable network conditions disturbing voltage variations may otherwise occur.

#### **Valid for Europe:**

The device is according to EMC (electromagnetic compatibility) requirements DIN EN 61326-1 see (⇒ 11).



#### **Useage Restriction**

To EMC standard DIN EN 61326-1:

**Class A** devices must not be operated by power networks with connected domestic areas! (⇒ 11)

#### **Valid for the USA:**

Instructions for Class A digital devices

“This equipment has been tested and found to comply with the limits for Class A digital device, pursuant to Part 15 of the FCC (Federal Communication Commission) Rules. These limits are designed to provide reasonable protection against harmful interference when the equipment is operated in a commercial environment. This equipment generates, uses, and can radiate radio frequency energy and, if not installed and used in accordance with the instruction manual, may cause harmful interference to radio communications. Operation of this equipment in a residential area is likely to cause harmful interference in which case the user will be required to correct the interference at his own expense.”

“This device complies with Part 15 of the FCC (Federal Communication Commission) Rules. Operation is subject to the following two conditions: (1) This device may not cause harmful interference, and (2) this device must accept any interference received, including interference that may cause undesired operation.”

#### **Valid for Canada:**

“This Class A digital apparatus complies with Canadian ICES-003” (ICES = Interference Causing Equipment Standards).

« Cet appareil numérique de la Classe A est conforme à la norme NMB-003 du Canada ».

## 1.2 Other safety information

- Only connect equipment to PE grounded mains sockets.
- At higher operating temperatures, parts of the bath cover can reach surface temperatures exceeding 70 °C. Be careful when touching it → Risk of burning!
- Use suitable hoses (⇒ 6.3).
- Secure hose against slippage with the aid of hose clips. Avoid kinks in the hoses.
- Check hoses from time to time for any possible material fatigue.
- Thermal medium hoses and other hot parts must not come into contact with the mains cable.
- With the use of thermostats as circulating thermostats hot liquid can be emitted when the hose breaks, presenting a hazard to persons and material.
- If no external load is connected, the pump outflow must be closed (use screw plugs) and the bypass valve must be set to "internal" (⇒ 4.3).
- Take into account the thermal expansion of the heat carrier oils with increasing bath temperature.
- Depending on the heat transfer liquid used and the type of operation, toxic vapors can arise. Ensure suitable extraction.
- When changing the heat transfer liquid from water to a thermal transfer medium for temperatures above 100 °C, carefully remove all water residues, including from the hoses and loads. **When doing this, also open the blanking caps of the pump outputs and inputs and blow compressed air through all the pump outputs and inputs.** → Risk of burning due to delay in boiling!
- Withdraw the mains plug before cleaning, maintenance or moving the thermostat.
- Specialist personnel must only carry out repairs in the control section.
- Figures of temperature constancy and display accuracy apply under normal conditions according to DIN 12876. Electromagnetic high frequency fields may in special cases lead to unfavorable values. Safety is not impaired.
- The following action may start the thermostat unintentionally from the standby mode: Previously activated timer mode (⇒ 7.12), "Start" command via interfaces (⇒ 8).

## 1.3 EU conformity

**EU conformity** The device complies with the basic health and safety requirements outline in the Directives listed below.



- Machinery Directive 2006/42/EC
- EMC Directive 2014/30/EU

LAUDA DR. R. WOBSEER GMBH & CO. KG – Pfarrstraße 41/43 –  
97922 Lauda-Königshofen – Germany



The device does not fall under Pressure Equipment Directive 2014/68/EU because the device is only classified as high as Category 1 and is covered by the Machinery Directive.

### 2 Brief operating instructions



These brief instructions shall give you the possibility to operate the unit quickly. For safe operation of the unit, it is necessary to read carefully all the instructions and safety notes!

1. Assemble unit and add items as appropriate (⇒ 6.1).  
The unit may NEVER be overturned nor put upside down!  
Take care of the hose tubing connections (⇒ 6.3 and 6.4).
2. Fill the unit with corresponding heat transfer liquid (⇒ 6.3). The units are designed for operation with non-flammable and flammable liquids to DIN EN 61010-2-010. → Take care of the level of the heat transfer liquid! (⇒ 6.2).
3. Compare the information on the rating label with the supply details.
4. Connect the unit only to a socket with a protective earth (PE) connection.

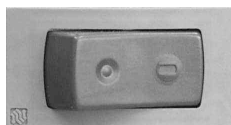

5. Check whether the main fuse-switch at the back is in the "On = —" position.



6. Switch the unit on with the switch at the front.



7. With  $T_{max}$  set the overtemperature cut-off point to a value clearly above room temperature (⇒ 7.14.1).
8. Now you see the current bath temperature in the display, for example:

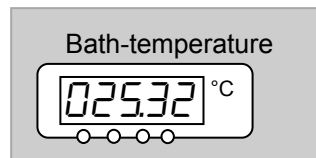

If instead, a warning or error message is displayed, then refer to Section 7.14.

**2.1 Menu structure: Master**

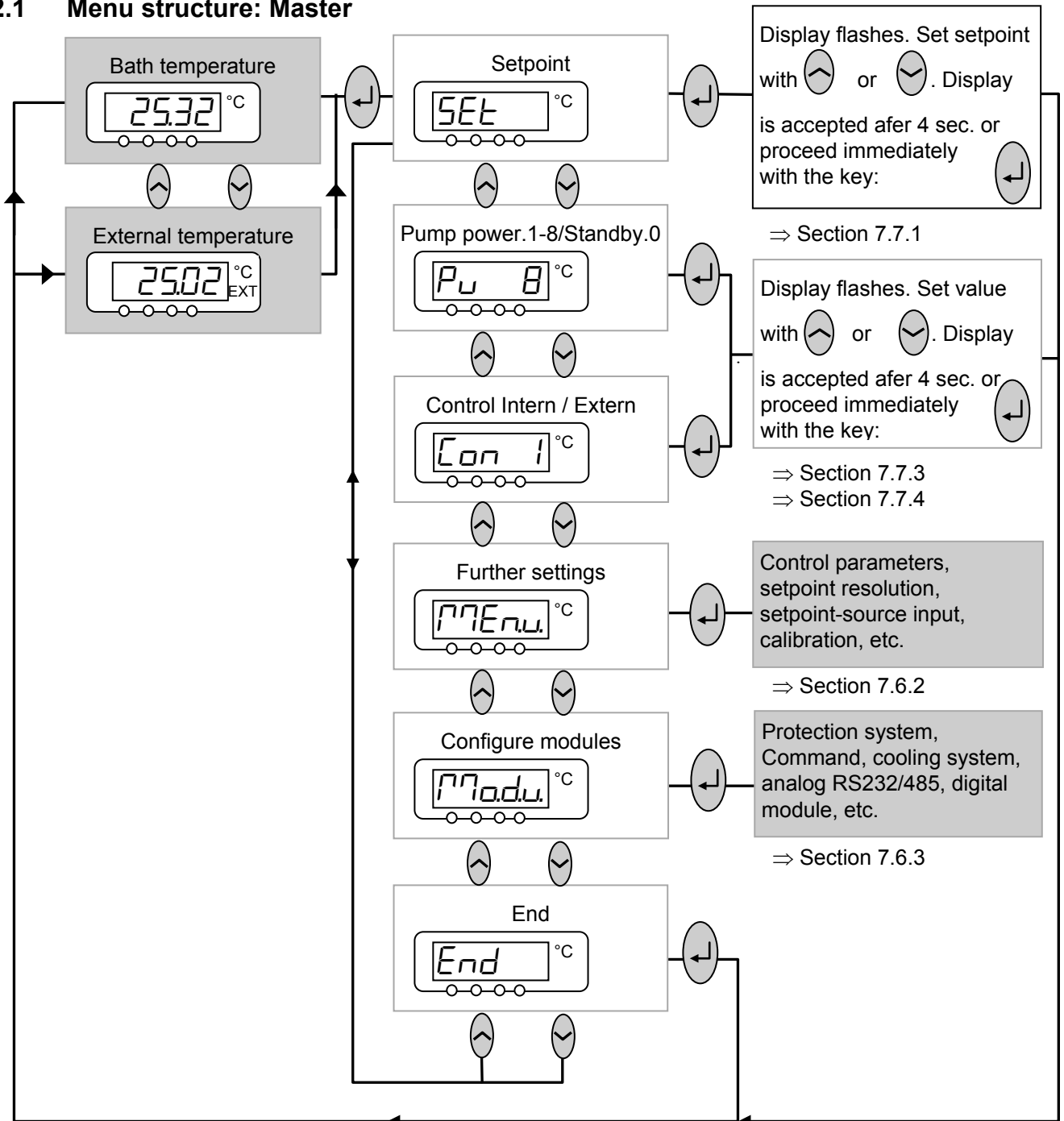

To reset the unit to the factory default state which enables basic operation with internal control, there is the default function in the menu  $PPEnu. \rightarrow PARP. \rightarrow DEF \Rightarrow 7.6.4.$

### 2.2 Menu structure: Command

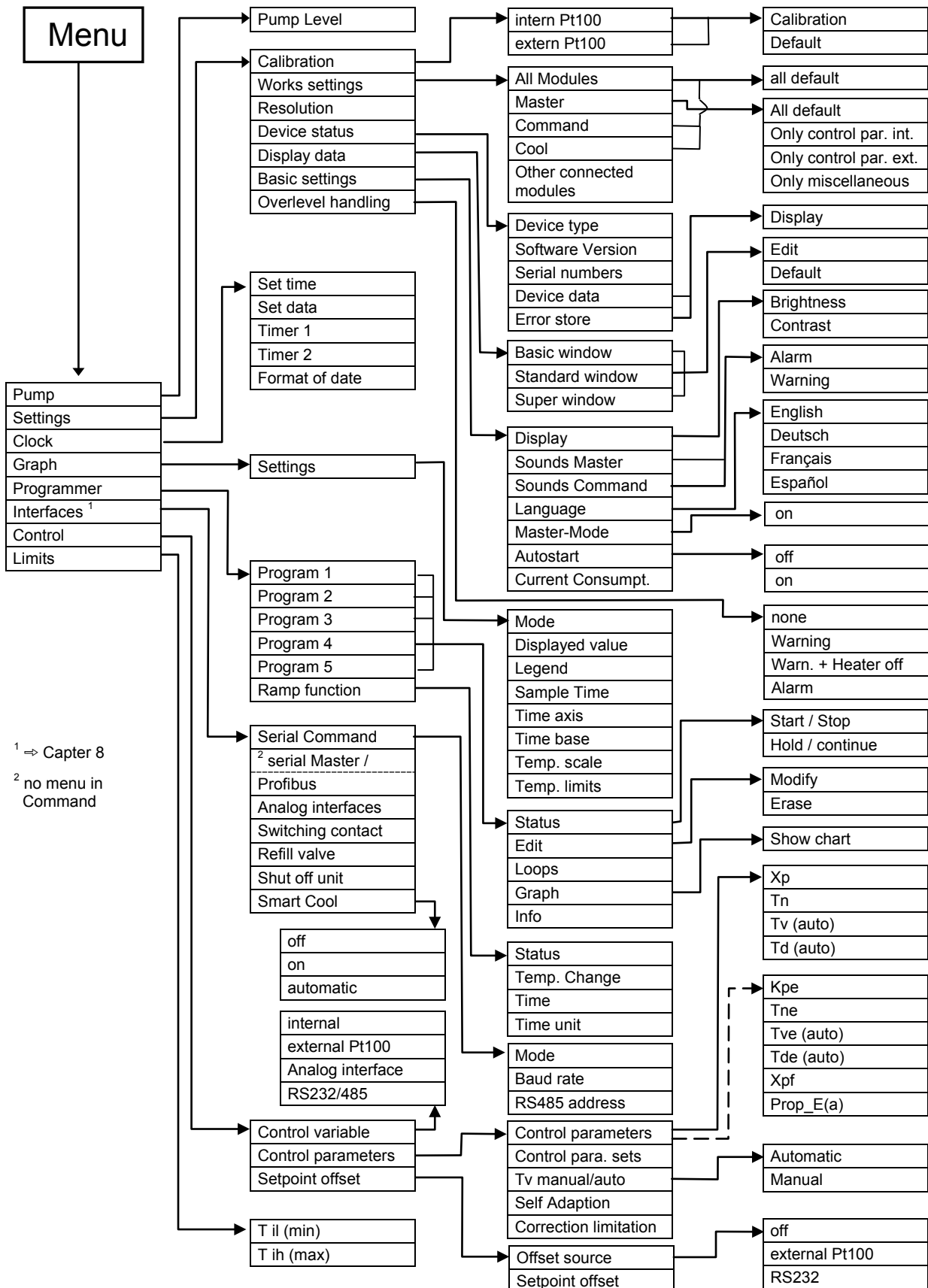

<sup>1</sup> ⇒ Chapter 8

<sup>2</sup> no menu in Command

**3 Controls and functional elements**

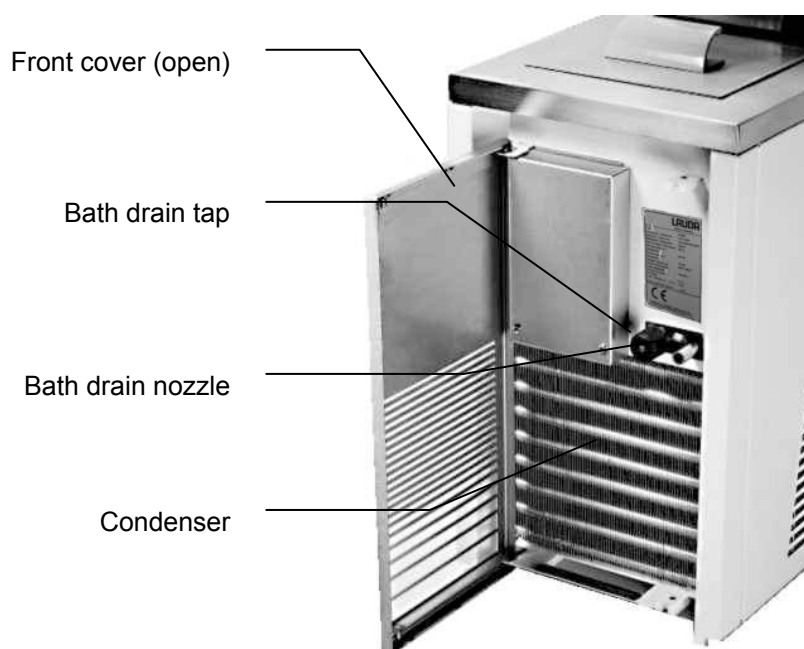
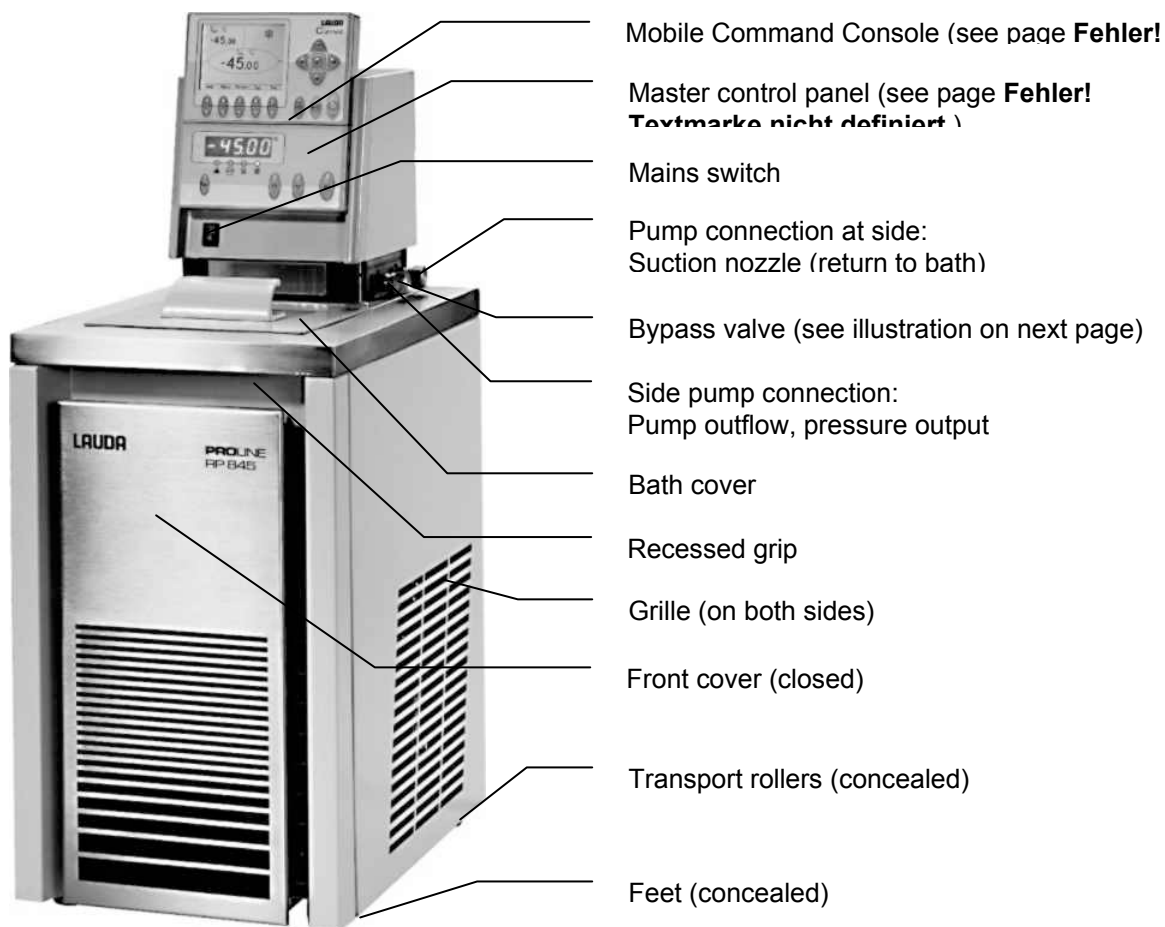

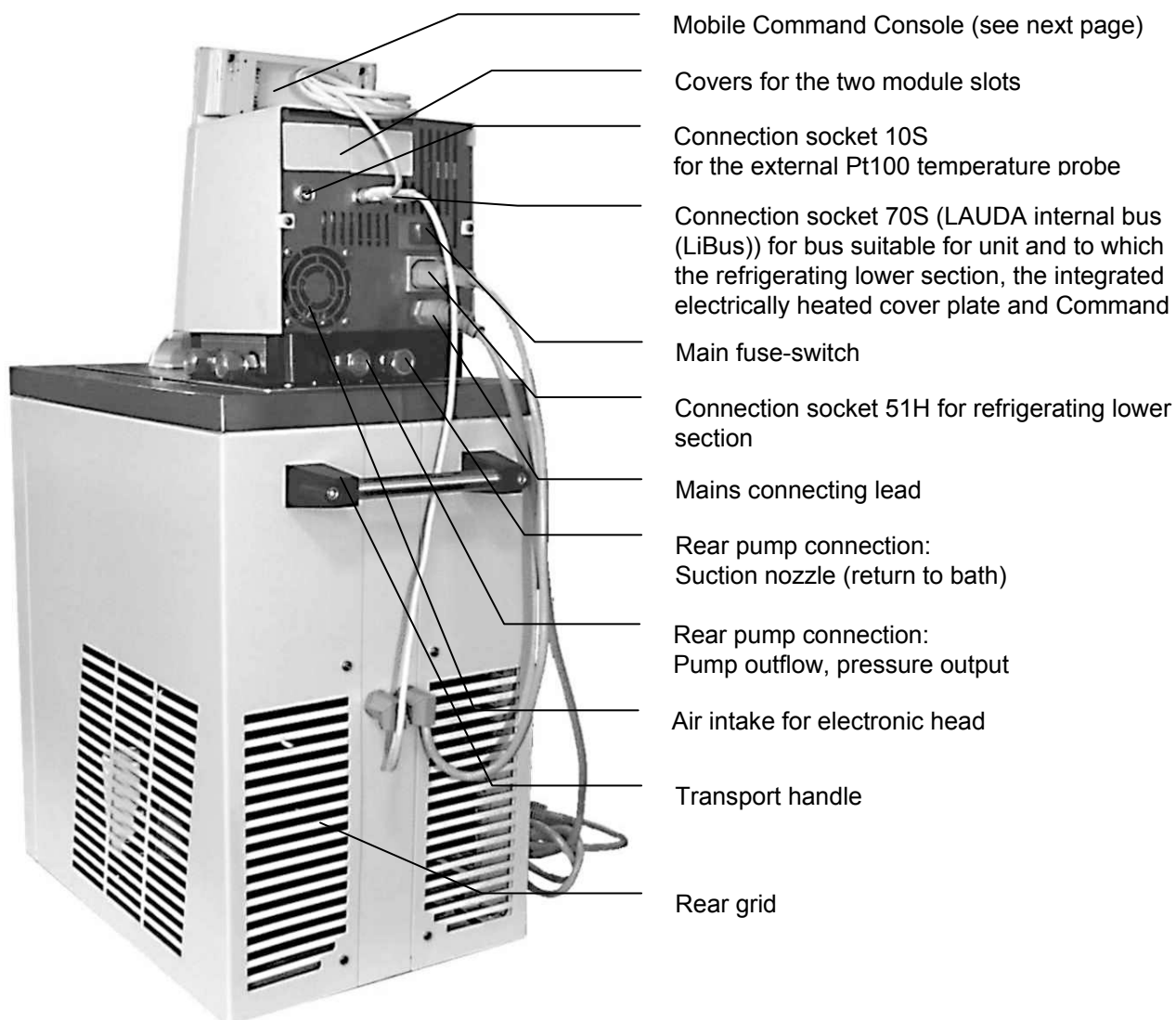

- Mobile Command Console (see next page)
- Covers for the two module slots
- Connection socket 10S for the external Pt100 temperature probe
- Connection socket 70S (LAUDA internal bus (LiBus)) for bus suitable for unit and to which the refrigerating lower section, the integrated electrically heated cover plate and Command
- Main fuse-switch
- Connection socket 51H for refrigerating lower section
- Mains connecting lead
- Rear pump connection: Suction nozzle (return to bath)
- Rear pump connection: Pump outflow, pressure output
- Air intake for electronic head
- Transport handle
- Rear grid

- Bypass valve (in "external" position)
- Side pump connection: Pump outflow, pressure output (closed off with screw plug)
- Side pump connection: Suction nozzle (return to bath) (closed off with screw plug)

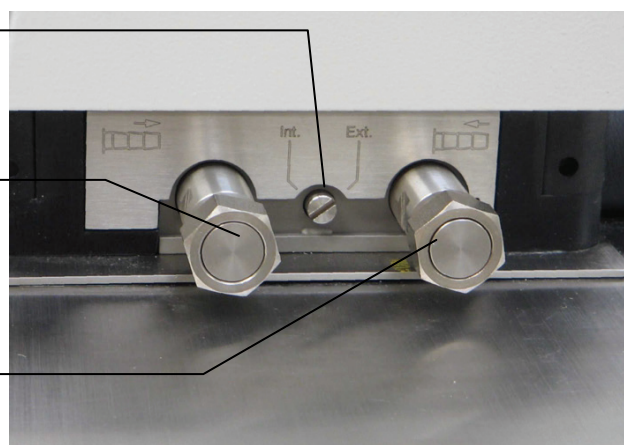



Control element: Master

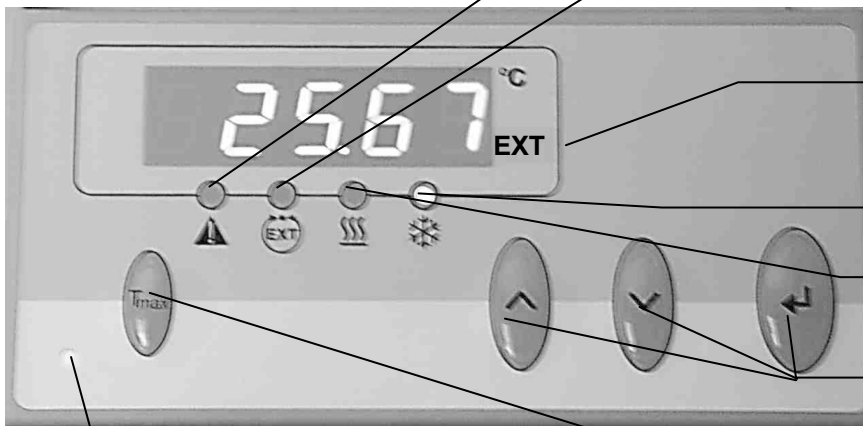

- Error signal (red LED blinking)
- Bath controlled by external temperature source (green LED lit)
- The temperature of an external source is displayed (EXT is lit green)
- Cooler active (blue LED is lit)
- Heater active (yellow LED is lit)
- Select and Enter keys
- Overtemperature set point to check or set  $T_{max}$

Mains On  
(green LED is lit)

Graphical display, here in the standard window displaying the values:

- Actual temperature  $T_{int}$  of internal bath temperature probe
- Setpoint temperature  $T_{set}$
- Actual temperature  $T_{ext}$  of the external temperature probe
- Bath level
- Pump level

Control element: Command

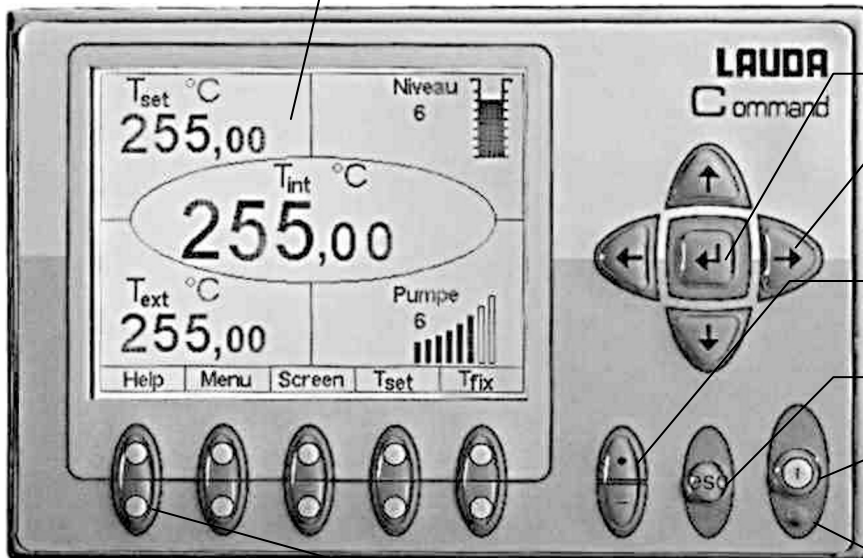

- Enter key
- Cursor key
- Decimal point or "-" symbol
- Escape key to quit a window without any
- Standby key, brings the thermostat into the idle mode. Heater,
- Yellow Stand-By LED
- 5 soft-key duo-keys – their associated functions are shown in the display.

RS232-socket  
(hidden on the back Command)

## 4 Unit description

### 4.1 Environmental conditions

The operation of the thermostats is only allowed under the following conditions as specified in DIN EN 61010-2-010:2003 and DIN EN 61010-1:2001:

- Indoor use.
- Altitude up to 2000 m above sea level.
- Foundation must be dense, even, non-slippery and non-flammable.
- Keep clear distance (⇒ 6.1 Assembly and siting).
- Ambient temperatures range (⇒ 11 Technical data).  
Use only within this range for an undisturbed operation.
- Mains supply voltage fluctuations (⇒ 11 Technical data).
- Relative humidity (⇒ 11 Technical data):
- Transient over voltage according to Installation Categories (Over voltage Categories) II.
- Pollution degree: 2.

### 4.2 Types of unit

The type designation of the Proline Low-Temperature Thermostats comprises the prefix R (to designate the refrigeration machine), a P for Proline, the bath volume in liters and the lowest bath temperature (guide figure without arithmetic sign).

Units in Command version are marked with a "C" at the end of the model description.

Examples: RP 855 is a low-temperature thermostat with 8-liter bath and -55 °C min. temperature.  
RP 1845 is a low-temperature thermostat with 18-liter bath and -45 °C min. temperature.

### 4.3 Varioflex pump

All units are fitted with a Varioflex pump with an 8-stage variable drive. The pump power can therefore be optimally matched to the relevant task: High pump pressure when, for example, long hoses pass to external loads or circulation is to be provided for a large bath. Low pressure when the heat input into the bath must be low.

As a pressure/suction pump, the Varioflex pump enables the very effective supply of pressure-sensitive glass reactors, which have a minimum permissible pressure rating. Furthermore, open vessels can be operated when a constant level controller (accessory LCZ 0660) is used.

At the right-hand side and at the back of the unit outflow and inflow nozzles are fitted for external loads. This means that up to two external loads can be directly connected without a distributor. Connections, which are not required, must be closed off with the supplied caps and union nuts. A bypass valve can subdivide the total volume flow variably between the bath (internally) and the connected load (externally). Consequently, no "pump short circuit" is needed. If no load is connected to the pump connector, the bypass valve must be set to the "internal" position for the best bath circulation.

In the heating range, the Varioflex pump operates up to viscosity values of 150 mm<sup>2</sup>/s. In the closed-loop control mode 50 mm<sup>2</sup>/s should not be exceeded. The temperature control is the best with 30 mm<sup>2</sup>/s and lower viscosity.

With small bath coolers (e.g. RP 845) power level 1 to 3 is practicable.

For operation as a circulating thermostat with an external load, a higher power level is practicable to maintain the temperature difference low, among other things also with higher temperatures in conjunction with oils as heat transfer liquid.

The pump connections on the unit are fitted with M16 x 1 thread.

The pump outflows of the Varioflex pump can be closed off without any impairment to the pump. Here, the "internal" setting of the bypass controller is recommended.

**Pump characteristics** (⇒ Section 11).

#### 4.4 Materials

All parts being exposed to the heat transfer liquid are made of high quality material appropriate to the operating temperature. Non-rusting stainless steel and high quality temperature-resistant, primarily solvent-resistant plastics are used.

#### 4.5 Temperature display, control and safety circuit

In the Master Version, the units are equipped with a 5-character green LED display, which is used for the display of the measurements and settings, as well as the operating status. The entry of setpoints and other settings occurs under menu guidance via four keys.

The extra features of the Command Version include a removable console with a backlit graphical display. The entry of the setpoint and other settings occurs under menu guidance via situation-dependent cursor keys and soft keys.

A Pt100 temperature probe acquires the outflow temperature in the bath. A high-resolution A/D converter processes the measurement. Further measurement conditioning occurs using a special control algorithm for controlling the heater actuator, which has a low reactive effect on the mains, and the SmartCool refrigeration equipment together with further transducers.

An external Pt100 can be connected via a socket (10S) for the acquisition of an external temperature. This value can be displayed and, if required, used as the controlled variable with external control (Master) switched on. In this way, the system controls the external measurement and not the outflow temperature (⇒ 7.7.4).

The safety system conforms to DIN EN 61010-2-010. The SelfCheck Assistant monitors about 50 unit parameters. A dual-channel system is used in which two microcontrollers monitor one another. Along with the bath temperature measurement and control probes, there are also two safety temperature probes (Pt100) for the safety circuit for the overtemperature cut-off and for monitoring the bath temperature probe.

The overtemperature cut-off point is displayed on pressing the key  on the Master.

Changing the overtemperature cut-off point: (⇒ 7.2 Switching on) on page 26.

The bath level is acquired by the SelfCheck Assistant in 8 stages. A permanent display is provided only with the Command Version. At the Master version, it is showed in the submenu *Show*. If the minimum level is undercut, the pump, heater and the SmartCool System refrigerating machine are switched off. The reaction of the thermostat in case of overfill can be set to simply display a warning, to display a warning and switch off the heater or to switch off the unit completely with pump, heater and SmartCool System refrigerating machine.

When the level is too low, with overtemperature, or with other alarms the SelfCheck Assistant switches the heater off on all poles. The pump and the refrigerating machine are also switched off.

This switch-off under fault conditions is retained, i.e. after the fault is rectified, the fault must be reset

(released) on the Master operating panel with the  key.

Other unit functions are described in the appropriate sections and in Section 7. (Starting up).

### 4.6 Programmer and ramp function

#### Master Version:

No programmer provided.

#### Command Version:

The units are equipped with a programmer function, which enables five temperature/time programs to be saved. Each program consists of a number of temperature/time segments. These also include details of how often the program is to be executed. Up to 150 segments can be distributed amongst the five programs.

With the ramp function, a rate of change can be directly entered in °C/ unit time (⇒ 7.10).

### 4.7 Interfaces

#### Master Version:

In the basic version, the Master unit is equipped with the following sockets at the back of the control head:

- For the connection of an external Pt100 temperature sensor (10S).
- Two sockets (70S) for the connection of components via the LAUDA equipment bus (cooling section, Command Console, external solenoid valve, etc.).

#### Command Version:

The Command unit is equipped as standard with the following sockets:

- For the connection of an external Pt100 temperature probe (10S).
- Two sockets (70S) for the connection of components via the LAUDA equipment bus (cooling section, Command Console, external solenoid valve, etc.)
- An RS232 / RS485 interface (65S) at the back of the Command Console.

### 4.8 Interface modules (accessories)

The Master and Command can be supplemented with further interface modules, which are simply inserted into two module slots (see Section 3) at the back of the control head.

The following modules are currently available :

1. **RS232 / 485 Interface Module** (Order No. LRZ 913) with 9-pole SUB-D socket. Electrically isolated through optocouplers. Command set largely compatible with the Ecoline, Integral XT and Integral T Series. The RS2323 interface can be directly connected to the PC with a cable wired 1:1 straight through (Order No. EKS 037). Further details can be found in section 8.3.

2. **Analog Module** (Order No. LRZ 912) with two inputs and two outputs on 6-pole DIN socket. The inputs and outputs can be set independently as 4...20 mA, 0...20 mA or 0...10 V interface. Further details can be found in section 8.4.
3. **Contact Module** (Order No. LRZ 915) on 15-pole SUB-D socket. With three relay contact outputs (changeover, max. 30V/ 0.2A) and three binary inputs for control via external voltage-free contacts. Plug 15-pole, Order No. EQM 030 and plug case Order No. EQG 017. Further details can be found in section 8.5.
4. **Contact Module** (Order No. LRZ 914) with connector to NAMUR NE28. Functionality as LRZ 915, but only one output and one input on each of two DIN sockets. Coupling socket 3-pole, LAUDA Order No. EQD 047 and coupling plug 3-pole, LAUDA Order No. EQS 048. Further details can be found in section 8.5.
5. **Profibus Modules** (Order No. LRZ 917). Further details can be found in the operating instructions of the **Profibus Modules** YAAE0020.

## 4.9 Cooling unit

The refrigerating machine mainly consists of one or two fully hermetically sealed compressors. The heat from the condensation process and the motor is dissipated via a lamellar condenser. Here, fresh air is drawn in at the front of the unit, heated towards the back and output at the side. To ensure proper air circulation the ventilation slots must not be restricted. See Section 6.1.

The coolers of the Proline Series are equipped with the SmartCool technology which makes optimum use of the compressor and only then cools when refrigerating capacity is demanded by the controller. To achieve this, a number of sensors in the cooling circuit monitor the operating conditions.

The compressors are equipped with overtemperature cutouts, which respond to the compressor temperature and the compressor current consumption. In addition, the refrigeration system is backed up by a pressure control device against over pressure. The cooling unit is normally switched in automatically, but can be switched manually via the operating menu. (⇒ Section 7.6 with Command und 7.6.3 with Master).

When the fault circuit trips, the cooling unit is also switched off.

Cooling curves (⇒ Section 11).

## 4.10 Avoidance of dewing

In order to avoid dewing on the edge of the bath when using the low temperature thermostats RP 855, RP 870, RP 890 and RP 1290, these instruments are equipped with a device for heating the edge of the bath, using the waste heat of the cooling unit.

As a standard feature, the minimum temperature thermostats RP 890 and RP 1290 are equipped with an additional electric heating of the bath bridge. This can be ordered as an option for RP 855 and RP 870.

With the bath covers of the minimum temperature thermostats, RP 890 and RP 1290, it is possible, by means of a nipple, to let nitrogen or dry air into the bath with a low volume flow.

## 4.11 Heater rating and power consumption from the mains

The Proline Low-Temperature Thermostats have an extraordinarily high heater rating of 3.5 kW maximum. If your mains fuse is rated below 16A, the current consumption can be reduced in steps from 16 A to 10 A (⇒ 7.7.5). The maximum heater rating of 3.5 kW is then, of course, also reduced accordingly.

### 5 Unpacking

After unpacking, firstly check the device and accessories for any damage in transit. If, contrary to expectations, there is visible damage to the unit, the shippers or the postal service must be immediately informed, so that an investigation can be made. Please also inform the LAUDA Service Constant Temperature Equipment (Contact ⇒ 9.4).

Standard Accessories:

Article number	Quantity	Article	
YACE0072	1	Operating instructions	for all cooling thermostats
HDQ 108	1	Bath cover	at RP 845, RP 855 and RP 870
HDQ 109	1	Bath cover	at RP 1840, RP 1845 and RP 3530
LCZ 9671	1	Bath cover for bath bridge heating	at RP 890 and RP 1290
HKO 026 (UD 413)	2	Hose olive Ø 13 mm	for all cooling thermostats
HKM 032	4	Union nuts for olives (M16 x 1)	for all cooling thermostats
HKN 065	4	Screw plugs (for M16 x 1)	for all cooling thermostats
EKS 073	1	T-piece adaptor cable for the internal LAUDA device bus (LiBus)	with Command cooling thermostats only
EZB 260	1	Warning label "Hot Surface" 	for all cooling thermostats

## 6 Preparation

### 6.1 Assembly and siting

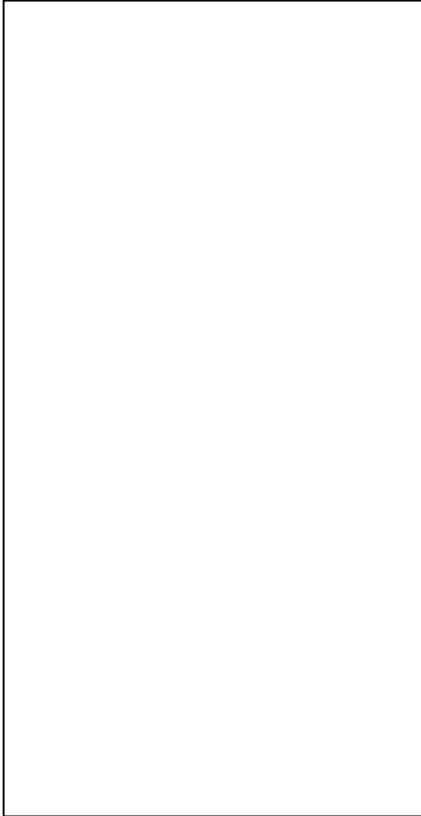

- Site the unit on a flat surface
- The unit must not be put into operation if its temperature during storage or transport has dropped below the dew point.  
Wait for about one hour.
- The unit may NEVER be overturned nor put upside down!
- Do not cover the ventilation openings at the back of the control head and on all sides of the lower section of the unit.
- Leave at least 40 cm of free space on all sides.
- For operation as bath thermostat, set the bypass valve to internal (without external loads) (⇒ Section 3).
- Plug the (high resistance) connector into the corresponding socket 51H on the back of the control head, the Bus-cable into the plug 70S and secure both.
- Only RP 890 and RP 1290: In case of disturbing dewing, connect the heating of the bath bridge. Plug the supplied T-piece adaptor cable for the LAUDA device bus into the 70S socket and secure it. Connect it with the connection cable of the bath bridge heating.
- Plug the bus connector of the Command console also into the 70S socket or into the T-piece and secure it.
- Further T-adaptors are available as accessories EKS 073.
- Avoid condensation of air humidity: Connect nitrogen or dry air with a low volume flow for superposition to the nipples of the bath covers of the minimum temperature thermostats RP 890 and RP 1290.



#### **Operation with external loads**

(Circulating thermostat) continue at (⇒ 6.4).



- Check whether the pump connectors at the side and back are fitted with sealing caps (⇒ 3) or that hoses are fitted for external loads.
- With bath temperatures, over 70 °C the supplied self-adhesive label  should be applied on the bath at an easily visible point.
- Do not carry out technical changes on the device!  
In particular, it is not allowed to bore into the edges of the bath!



- The unit can be safely operated up to an ambient temperature of 40 °C.
- An increased ambient temperature reduces the cooling capacity.

### 6.2 Filling and draining

#### Filling

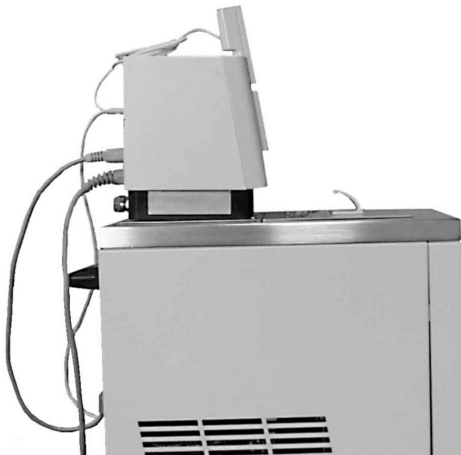

- Close the drain cock.
- Carefully remove all residues of the previous heat transfer liquid (blow dry and remove screw plugs!).
- Maximum filling level is up to 10 mm below the top edge of the bath. Overfilling leads to the display of the warning **WArn 103** (⇒ 7.14.4).
- Best operation is with a level 20 – 80 mm below the top edge of the bath.
- The cooling pipe of the evaporator should be covered. Depending on the operation up to three pipe windings might be uncovered.
- Low-level cut-off occurs at about 95 mm below the top edge of the bath.



- The units are designed for use with non-flammable and flammable liquids to DIN EN 61010-2-010. Flammable liquids must not be used higher than 25 °C below the fire point (⇒ 6.3).
- When using heat transfer oils note that they expand on heating (approx. 10 %/100 °C).
- With enclosed external loads, the overall expansion takes place in the bath.
- Ensure that with the connection of an external load, the liquid level does not drop impermissibly due to filling the load → top up with liquid if necessary.
- Set the upper and lower temperature limits (⇒ 7.8.3) in accordance with the limits of the heat transfer liquid in use.

#### Draining



Drain cock

- Switch off the thermostat withdraw the mains plug.
- Let out the heat transfer liquid through the drain cock; fit a hose when doing this.
- On thermostats, the drain cock is located behind the front panel.
- Completely drain the bath, external consumers, accessories and hose connections and flush or clean them (e.g. with new heat transfer liquid).



- Follow the regulations for the disposal of used heat transfer liquid.



Do not drain heat carrier liquid when hot or at bath temperatures below 0 °C!



### 6.3 Heat transfer liquids and hoses

#### Approved heat transfer liquids

LAUDA designation	Temperature range	Chemical designation	Viscosity (kin)	Viscosity (kin) at temperature	Fire point	Packing drum Catalogue number		
						5 L	10 L	20 L
	from °C to °C		mm <sup>2</sup> /s at 20°C	mm <sup>2</sup> /s				
Aqua 90 ①	5...90	Decalcified water	1	--	--	LZB 120	LZB 220	LZB 320
Kryo 90	-90...30	Silicone oil	1.76	15 at -70 °C	≥ 56	LZB 128	LZB 228	LZB 328
Kryo 60	-60...80	Silicone oil	3	25 at -60 °C	> 110	LZB 102	LZB 202	LZB 302
Kryo 51	-50...120	Silicone oil	5	34 at -50 °C	> 160	LZB 121	LZB 221	LZB 321
Kryo 40	-40...60	Hydrous alcalisalt solution	2.36	24 at -40 °C	--	LZB 119	LZB 219	LZB 319
Kryo 30 ②	-30...90	Monoethylene glycol/ water	4	50 at -25 °C	--	LZB 109	LZB 209	LZB 309
Kryo 20	-20...180	Silicone oil	11	28 at -20 °C	> 230	LZB 116	LZB 216	LZB 316
Therm 160	60...160	Polyalkylene glycol	141	28 at 60 °C	> 273	LZB 106	LZB 206	LZB 306
Therm 180	0...180	Silicone oil	23	36 at 0 °C	> 270	LZB 114	LZB 214	LZB 314
Therm 240	50...240	Silicone oil	125	25 at 70 °C	≥ 378	LZB 122	LZB 222	LZB 322



- ① At higher temperatures → Evaporation losses → Use bath covers.  
Only use distilled water or fully demineralized high purity water after adding 0.1 g of soda (Na<sub>2</sub>CO<sub>3</sub> sodium carbonate) / liter of water, → Risk of corrosion!
- ② Water content falls with longer operation at high temperatures → Mixture becomes flammable (flash point 128 °C). → Check the mixture ratio with a hydrometer.
- At devices with nickel-plated evaporator (RP 845, RP 855, RP 890, RP 1290 and RP 1845) you must not use acid, aqueous heat transfer liquids resp. detergents (ph-value < 7).
  - With the selection of the heat transfer liquid, it should be noted that impairment of the properties is to be expected at the lower limit of the temperature range due to increasing viscosity. Therefore, only make maximum use of temperature ranges when essential.
  - Application ranges of heat transfer liquids and hoses are general figures, which may be restricted by the operating temperature range of the units.



With silicone rubber, silicone oils lead to substantial swelling → Never use silicone oil with silicone hoses.

Safety data sheets can be ordered if required.

### Hoses

#### a) Elastomer hoses

Hose type	Internal width Ø mm	Temperature range °C	Field of application	Catalogue number
EPDM hose uninsulated	9	10...90	For all LAUDA heat transfer liquids except Ultra 350 and mineral oils	<b>RKJ 111</b>
EPDM hose uninsulated	12	10...90	For all LAUDA heat transfer liquids except Ultra 350 and mineral oils	<b>RKJ 112</b>
EPDM hose insulated	12 External Ø. approx. 30 mm	-35...90	For all LAUDA heat transfer liquids except Ultra 350 and mineral oils	<b>LZS 021</b>
Silicone hose uninsulated	11	10...100	Water Water/ glycol mixture	<b>RKJ 059</b>
Silicone hose insulated	11 External Ø. approx. 30 mm	-60...100	Water Water/ glycol mixture	<b>LZS 007</b>
 <ul style="list-style-type: none"> <li>– EPDM hose is <u>not</u> suitable for Ultra 350 and <u>not</u> suitable for mineral oils.</li> <li>– With silicone rubber, silicone oils lead to substantial swelling → never use silicone oil with silicone hoses.</li> <li>– Secure hoses against slippage with hose clips.</li> </ul>				

#### b) Metal hoses in non-rusting stainless steel with union nut M16 x 1, internal width 10 mm.

Type	Length (cm)	Temperature range °C	Field of application	Catalogue number
MC 50	50	10...400	With single insulation, for all heat transfer liquids	<b>LZM 040</b>
MC 100	100	10...400		<b>LZM 041</b>
MC 150	150	10...400		<b>LZM 042</b>
MC 200	200	10...400		<b>LZM 043</b>
MK 50	50	-90...150	With foam insulation for refrigeration range, for all heat transfer liquids	<b>LZM 052</b>
MK 100	100	-90...150		<b>LZM 053</b>
MK 150	150	-90...150		<b>LZM 054</b>
MK 200	200	-90...150		<b>LZM 055</b>

## 6.4 Connecting external loads



- Operation as circulating thermostat**
- When used as circulation thermostat, care for shortest hose connections with largest inner diameter as possible. This gives the best flow.
  - Push hose with 11 – 12 mm internal width onto hose olive or connect metal hoses (⇒ 6.3) to pump connectors.
  - Pump connectors at side:  
Inlet and outflow ⇒ see labeling housing.
  - Pump connectors at back:  
Inlet and outflow ⇒ see labeling housing.
  - Set bypass valve to "external" (⇒ 3).
- If cross-sectional area of tube is too low → temperature gradient between bath and external load due to low flow rate.
  - Always ensure the largest possible passages in the external circuit.
  - When tightening the union nuts on the pump nipple AF 19, use a wrench AF 14 to counter the tightening torque (see figure).
  - If external control is to be used, provide a Pt100 probe in the external load (⇒ Section 7.7.2 and 7.7.4).



- With loads at a higher position and with stationary pump and ingress of air into the thermostatic circuit, the external volume can drain away, even with closed circuits → Risk of thermostat overflowing!
- Secure hoses against slippage with hose clips.
- Unused pump connectors must be closed off.

### 7 Starting up

#### 7.1 Mains connection

Compare the rating on the nameplate (back of control head and behind the front panel) with the mains voltage.



- Connect unit only to sockets with a protective earth conductor (PE).
- No liability is accepted for incorrect mains connections.
- Ensure that pump connectors without external loads are closed off.
- Ensure that the unit is filled according to Section 6.2.

#### 7.2 Switching on

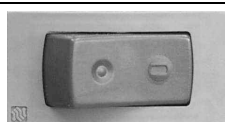

Check whether the main fuse switch at the back is in the "On = **—**" position.



Switch on the mains switch:



1 s

- The green LED for "Mains ON" is lit,
- an acoustic signal is emitted for about 1 second,
- it is quite normal if the refrigerating machine makes a rattling sound for a few seconds.
- The unit starts its self-test. All display segments and symbols appear for about 1 second.

Self-test



Bath temperature

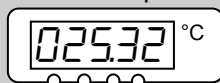

- The momentary bath temperature is displayed,
- the pump starts provided "Standby" or "Manual start" (⇒ Section 7.8.2) has not been programmed,
- all values are accepted which were active before switch-off.

Overtemp. cut-off

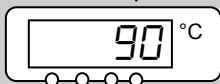

Check or set overtemperature cut-off point:



- The switching point is shown in the LED display on pressing the key





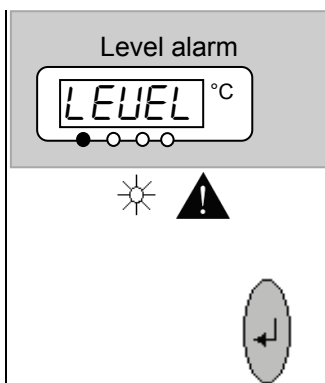

- Change overtemperature cut-off (⇒ 7.14.1) Overtemperature protection and checking on page 96.
- If necessary, top up heat transfer liquid, this has been pumped out by filling the external load.



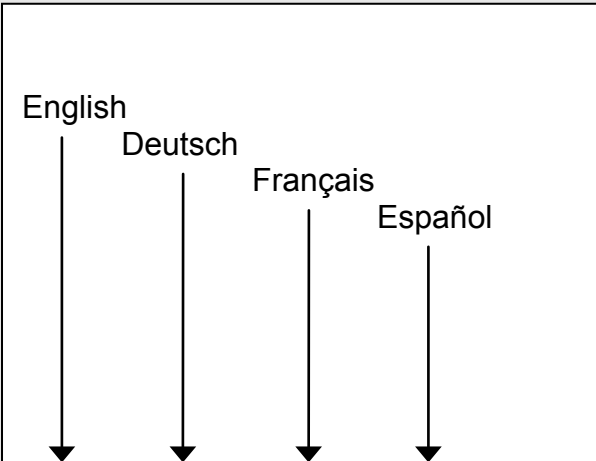

- Display for **LEVEL** (low level) appears when the bath has too little liquid.
- Red LED  above the fault triangle  flashes.
- Find cause of fault and, where necessary, top up missing heat transfer liquid (⇒ Section 6.3).
- Press the Enter key.
- Also, press the key if unit has been switched off in the fault state.
- No release is possible on Command Console!

Command	Language
	<ul style="list-style-type: none"> <li>- If the Command Console is being switched on for the first time, the illustrated window appears automatically, enabling you to select the dialog language with the appropriate soft key.</li> </ul>
<div style="border: 1px solid black; padding: 5px;"> <p>Display Sounds Master Sounds Command <b>Language</b> Master-Mode Autostart Current Consumpt.</p> </div> <div style="border: 1px solid black; padding: 5px; margin-top: 5px;"> <p>English <b>Deutsch</b> Français Español</p> </div> <div style="display: flex; justify-content: space-between; margin-top: 5px;"> <span>Pump</span> <span>Menu</span> <span>End</span> <span>T<sub>set</sub></span> <span>T<sub>fix</sub></span> </div>	<ul style="list-style-type: none"> <li>- The dialog language also can be changed later via <b>Settings</b> → <b>Basic settings</b> → <b>Language</b>.</li> <li>- Mark the required language with  or .</li> <li>- Confirm the selection with .</li> </ul>

### 7.3 Switching off / standby

**Switching off:** Set mains switch to position 0. With operation at temperatures below 0° Celsius only switch off the device via standby, because otherwise severe condensation and dew formation can occur.

**Standby operation:** Use the key  on the command console or by selecting the pump level Zero on the master display. The pump, heating and cooling unit are switched off, but the operating display and the electrical bath bridge heating for RP 890 and RP 1290 remain active, so that dew formation and condensation into the bath continue to be suppressed.



However, a started timer (⇒ 7.12) continues to run. Stop as required with Pause.

### 7.4 Key functions

Your Proline Thermostat is easy to operate.

#### 7.4.1 General key functions and pilot lamps

##### Master



Enter key:

- From the actual-value display at the main menu level,
- activates input, display flashes,
- saves input, display ceases to flash and menu point is left,
- press for approx. 3 seconds: Exit function and returns to bath temperature display.



or



- Paging with keys is possible within the relevant level, or setting of numerical values

Speeds up entry by moving the counting position to the left:

- a) Keys are pressed and held down **or**
- b) one of the two keys is pressed and held down, followed immediately by brief pressing of the other key.





Moves counting position to the right:



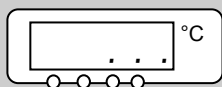

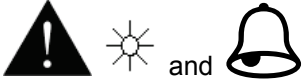

- Switching one **place to the right** occurs by briefly (1 second) releasing the key, followed by another pressing of the key.

Useful additional information:

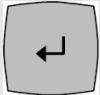
- 2 dots in the Master display indicate that a submenu follows.
- 3 dots in the display indicate that a submenu for a module (interface...) or a component (thermostat, Command Console ...) follows. Module/component-specific possible settings are only displayed when the hardware is connected.

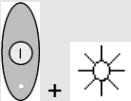

	<ul style="list-style-type: none"> <li>- <b>The following always applies:</b> After termination of the relevant settings, they are accepted automatically after approx. 4 s or</li> <li>- the setting is accepted immediately with the Enter key.</li> </ul>
	<ul style="list-style-type: none"> <li>- Fault signal: Flashing red Alarm LED and acoustic signal.</li> <li>- An acoustic signal can only sound when it has not been intentionally deactivated! (⇒ 7.8.6).</li> </ul>
	<ul style="list-style-type: none"> <li>- The bath control occurs via the external temperature probe when the green LED is lit.</li> </ul>
	<ul style="list-style-type: none"> <li>- Heating is active when the yellow LED is lit.</li> </ul>
	<ul style="list-style-type: none"> <li>- Cooling is active. When the setpoint temperature is lowered, it may take up to one minute before the blue LED is lit.</li> </ul>
<b>EXT</b>	<ul style="list-style-type: none"> <li>- The temperature of the external probe is displayed.</li> </ul>

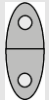
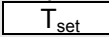
Command	
	<ul style="list-style-type: none"> <li>- Enter key ("Confirm selection") and go back one level.</li> </ul>
	<ul style="list-style-type: none"> <li>- Soft key function to confirm a selection or input and to return to the main display window.</li> </ul>
	<ul style="list-style-type: none"> <li>- Escape key to quit a window without changes and to go back one level.</li> </ul>
	<ul style="list-style-type: none"> <li>- Cursor keys for Up, Down, Left and Right.</li> </ul>
	<ul style="list-style-type: none"> <li>- Standby activation (pump, heater and refrigerating machine are deactivated when the yellow LED is lit). However, timer continues to run! Refer to safety information in ⇒ 7.7.3.</li> </ul>
	<p>Duo key:</p> <ul style="list-style-type: none"> <li>- Top: Decimal-point key.</li> <li>- Bottom: Key for arithmetical sign.</li> </ul>
	<ul style="list-style-type: none"> <li>- Soft keys: 5 duo-keys, which each have the function shown in display above them. Soft-key entries are shown framed in the operating instructions. Example: You would like to change the setpoint temperature then press the duo-key under</li> </ul>
	

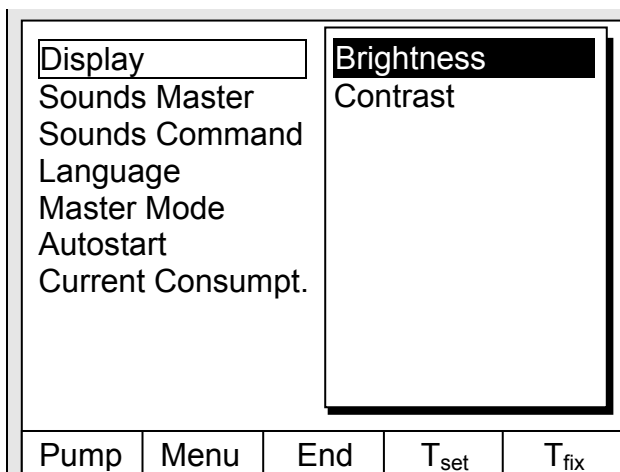

### Brightness Contrast

The brightness and contrast can be set on the Command Console:

- The works setting can be changed via  
 → **Settings** → **Basic settings**  
 → **Display** → **Brightness** or  
 → **Contrast** .
- The brightness of the LCD illumination can be selected from eight steps or switched off completely.
- The contrast can be set in eight steps.

There are four different screen displays available.

The screen is switched over with the soft key **Screen** :

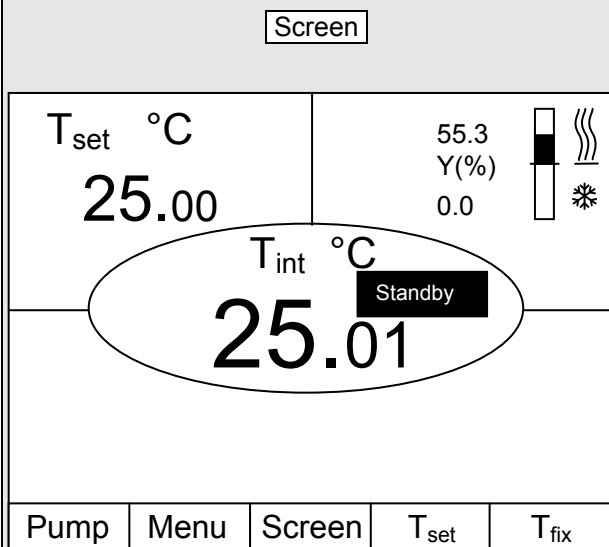

### 1. Basic window with the three most important items of information:

- $T_{int}$ , current bath temperature,
- $T_{set}$ , setpoint of the bath or external temperature,
- Information: Heating / cooling. Here, heating is taking place at 55.3% and 0.0% cooling.

### Soft keys:

- Pump: Set pump level
- Menu: Set unit parameters.
- Screen: Changes between basic, normal, super and graphics recorder windows.
- $T_{set}$ : Changes setpoint temperature.
- $T_{fix}$ : Calling and setting of saved setpoints.

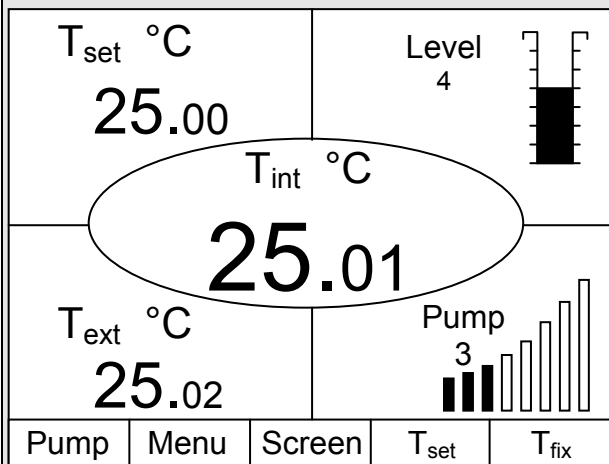

### 2. Standard window with five important items of information:

- $T_{int}$ , current bath temperature,
- $T_{set}$ , setpoint,
- $T_{ext}$ , current temperature on external probe (if connected),
- Level of heat transfer liquid in cm above the minimum level,
- Pump level of the Varioflex Pump.

Soft keys see as above.



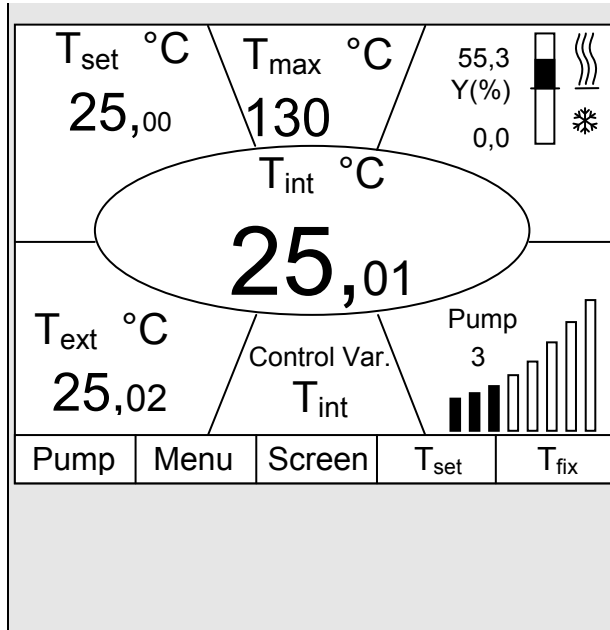

**3. Super window** with seven items of information:

- $T_{int}$ , current bath temperature.
- $T_{set}$ , setpoint.
- $T_{ext}$ , current temperature on external probe (if connected).
- Overtemperature cut-off point  $T_{max}$ .
- Pump level of the Varioflex Pump.
- Control variable to  $T_{int}$  or  $T_{ext}$ .
- Information: Heating / cooling.

Soft keys see as above.

**4. Graphical measurement display**





- All temperature values can be shown graphically against time ( $\Rightarrow$  7.9).

### 7.4.2 Changing window information (Command Console)

Command	Display data																																	
<div style="border: 1px solid black; padding: 5px; margin-bottom: 5px;"> <table style="width: 100%; border-collapse: collapse;"> <tr> <td style="width: 50%; text-align: center; padding: 5px;"> <math>T_{set}</math> °C <b>25.00</b> </td> <td style="width: 50%; text-align: center; padding: 5px;">           Level 4  </td> </tr> <tr> <td colspan="2" style="text-align: center; padding: 5px;"> <math>T_{int}</math> °C <b>25.01</b> </td> </tr> <tr> <td style="text-align: center; padding: 5px;"> <math>T_{ext}</math> °C <b>25.02</b> </td> <td style="text-align: center; padding: 5px;">           Pump 3  </td> </tr> <tr> <td style="text-align: center; padding: 5px;">Pump</td> <td style="text-align: center; padding: 5px;">Menu</td> <td style="text-align: center; padding: 5px;">Screen</td> <td style="text-align: center; padding: 5px;"><math>T_{set}</math></td> <td style="text-align: center; padding: 5px;"><math>T_{fix}</math></td> </tr> </table> </div> <div style="border: 1px solid black; padding: 5px; margin-bottom: 5px;"> <table style="width: 100%; border-collapse: collapse;"> <tr> <td style="width: 60%; padding: 5px;">           Basic Window            Standard Window            Super Window         </td> <td style="width: 40%; padding: 5px;"> <div style="border: 1px solid black; padding: 5px;">             Edit              Default           </div> </td> </tr> <tr> <td style="text-align: center; padding: 5px;">Pump</td> <td style="text-align: center; padding: 5px;">Menu</td> <td style="text-align: center; padding: 5px;">End</td> <td style="text-align: center; padding: 5px;"><math>T_{set}</math></td> <td style="text-align: center; padding: 5px;"><math>T_{fix}</math></td> </tr> </table> </div> <div style="border: 1px solid black; padding: 5px;"> <table style="width: 100%; border-collapse: collapse;"> <tr> <td style="width: 30%; padding: 5px;">           Center            Up left            Up right            Down left            Down right         </td> <td style="width: 70%; padding: 5px;"> <div style="border: 1px solid black; padding: 5px;"> <math>T</math> internal  <math>T</math> external            Setpoint  <b><math>T</math> max</b>            Pump step            Set value            Level            Control variable            Date/time            Programmer         </div> </td> </tr> <tr> <td style="text-align: center; padding: 5px;">Pump</td> <td style="text-align: center; padding: 5px;">Menu</td> <td style="text-align: center; padding: 5px;">End</td> <td style="text-align: center; padding: 5px;"><math>T_{set}</math></td> <td style="text-align: center; padding: 5px;"><math>T_{fix}</math></td> </tr> </table> </div>	$T_{set}$ °C <b>25.00</b>	Level 4	$T_{int}$ °C <b>25.01</b>		$T_{ext}$ °C <b>25.02</b>	Pump 3	Pump	Menu	Screen	$T_{set}$	$T_{fix}$	Basic Window Standard Window Super Window	<div style="border: 1px solid black; padding: 5px;">             Edit              Default           </div>	Pump	Menu	End	$T_{set}$	$T_{fix}$	Center Up left Up right Down left Down right	<div style="border: 1px solid black; padding: 5px;"> <math>T</math> internal  <math>T</math> external            Setpoint  <b><math>T</math> max</b>            Pump step            Set value            Level            Control variable            Date/time            Programmer         </div>	Pump	Menu	End	$T_{set}$	$T_{fix}$	<p>You can adapt the information displayed by your Command Console to your requirements. For example, if you have not connected any temperature probe, you can exchange it in the standard setting of the normal window for the maximum temperature <math>T_{max}</math> (safety cut-off).</p> <p>This is how it is done:</p> <ul style="list-style-type: none"> <li>- Open the unit parameter menu via the soft key <b>Menu</b>.</li> <li>- With  and  change from             <table style="margin-left: 20px; border-collapse: collapse;"> <tr><td style="background-color: black; color: white; padding: 2px;">Settings</td><td style="padding: 0 5px;">→</td></tr> <tr><td style="background-color: black; color: white; padding: 2px;">Display Data</td><td style="padding: 0 5px;">→</td></tr> <tr><td style="background-color: black; color: white; padding: 2px;">Standard Window</td><td style="padding: 0 5px;">→</td></tr> <tr><td style="background-color: black; color: white; padding: 2px;">Edit</td><td></td></tr> </table> </li> <li>-  or  takes you to the illustrated window.</li> <li>-  and  marks <b><math>T</math> max</b> as illustrated.</li> <li>- Confirm selection with  or <b>End</b>,</li> <li>- or quit the window with  without any changes being made.</li> </ul>	Settings	→	Display Data	→	Standard Window	→	Edit	
$T_{set}$ °C <b>25.00</b>	Level 4																																	
$T_{int}$ °C <b>25.01</b>																																		
$T_{ext}$ °C <b>25.02</b>	Pump 3																																	
Pump	Menu	Screen	$T_{set}$	$T_{fix}$																														
Basic Window Standard Window Super Window	<div style="border: 1px solid black; padding: 5px;">             Edit              Default           </div>																																	
Pump	Menu	End	$T_{set}$	$T_{fix}$																														
Center Up left Up right Down left Down right	<div style="border: 1px solid black; padding: 5px;"> <math>T</math> internal  <math>T</math> external            Setpoint  <b><math>T</math> max</b>            Pump step            Set value            Level            Control variable            Date/time            Programmer         </div>																																	
Pump	Menu	End	$T_{set}$	$T_{fix}$																														
Settings	→																																	
Display Data	→																																	
Standard Window	→																																	
Edit																																		

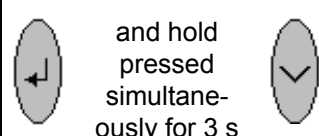
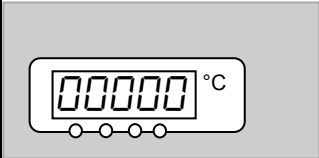
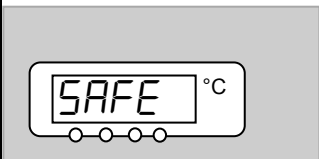
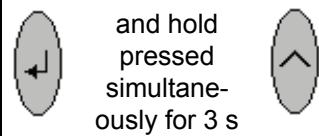
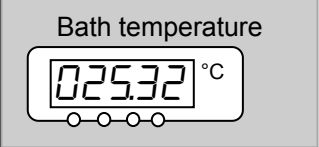
### 7.4.3 Locking the keyboard



The keyboards of the Master and the Command Console can be locked independently of one another. This is especially advantageous when the thermostat is positioned in another room and the Command Console is used as a remote control device. Then the Master keyboard can be locked to prevent unintentional adjustment.

<p><b>Master</b></p>  <p>and hold pressed simultaneously for 3 s</p>    <p>and hold pressed simultaneously for 3 s</p> <p>Bath temperature</p> 	<p><b>SAFE</b></p> <p><b>Locking:</b></p> <ul style="list-style-type: none"> <li>- <i>SEt</i> appears for 3 seconds,</li> <li>- then the segments of the first right-hand  are formed,</li> <li>- hold both keys pressed until this display is <u>completely</u> visible.</li> </ul> <p>- <i>SAFE</i> flashes briefly and the display returns to the actual temperature.</p> <ul style="list-style-type: none"> <li>- The Master keyboard is now locked.</li> <li>- The <i>SAFE</i> display signals the locked state when any Master key is pressed.</li> </ul> <p><b>Unlocking:</b></p> <ul style="list-style-type: none"> <li>- For three seconds, then <i>SAFE</i> appears.</li> <li>- Then the segments of the left-hand  are formed.</li> <li>- The actual bath temperature appears again when all the s have been formed.</li> </ul>
---	---

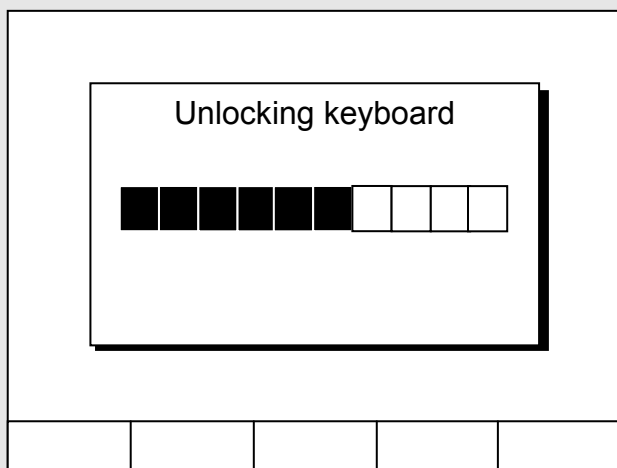
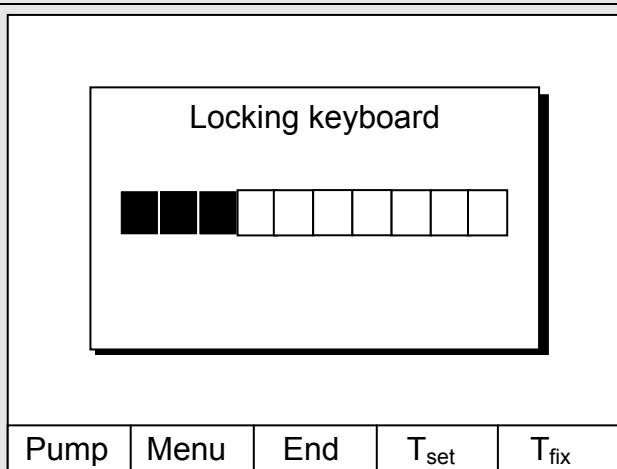

### Command



#### Locking:

- Press  and then  and hold pressed simultaneously for three seconds.
- The locking window appears.
- Hold both keys pressed until the progress bar is completely filled.
- Then the display skips back to the previously set **Screen** mode.
- The soft-key boxes are now blank, indicating that the keyboard is locked.
- On pressing any Master key the display appears:  
**Keyboard locked**

#### Unlocking:

- Press  and then  and hold pressed simultaneously for three seconds.
- The unlocking window appears.
- Hold both keys pressed until the progress bar is completely filled.
- Then the display skips back to the previously set **Screen** mode.

**7.5 "Master" menu structure**

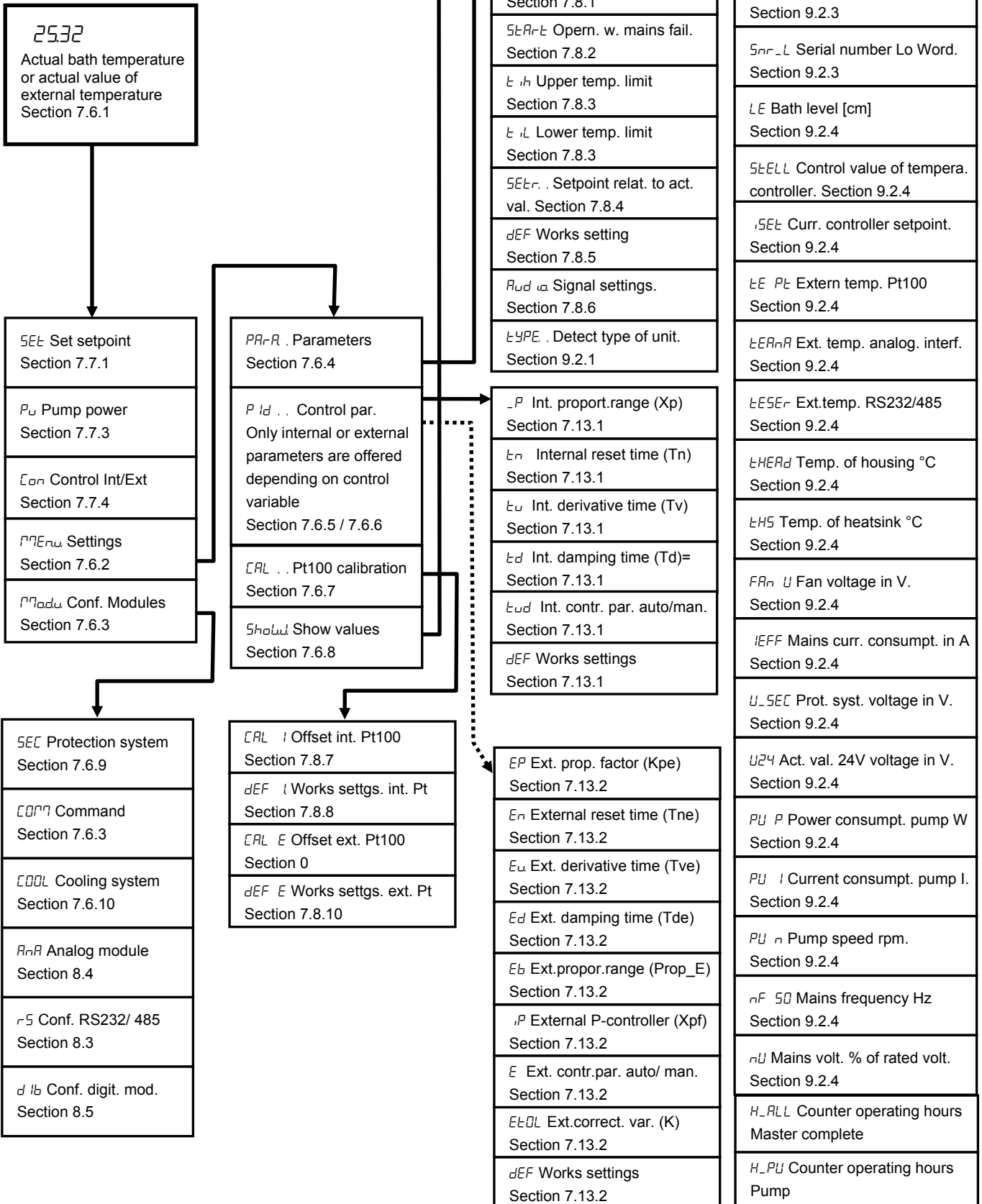

### 7.6 "Command" menu structure

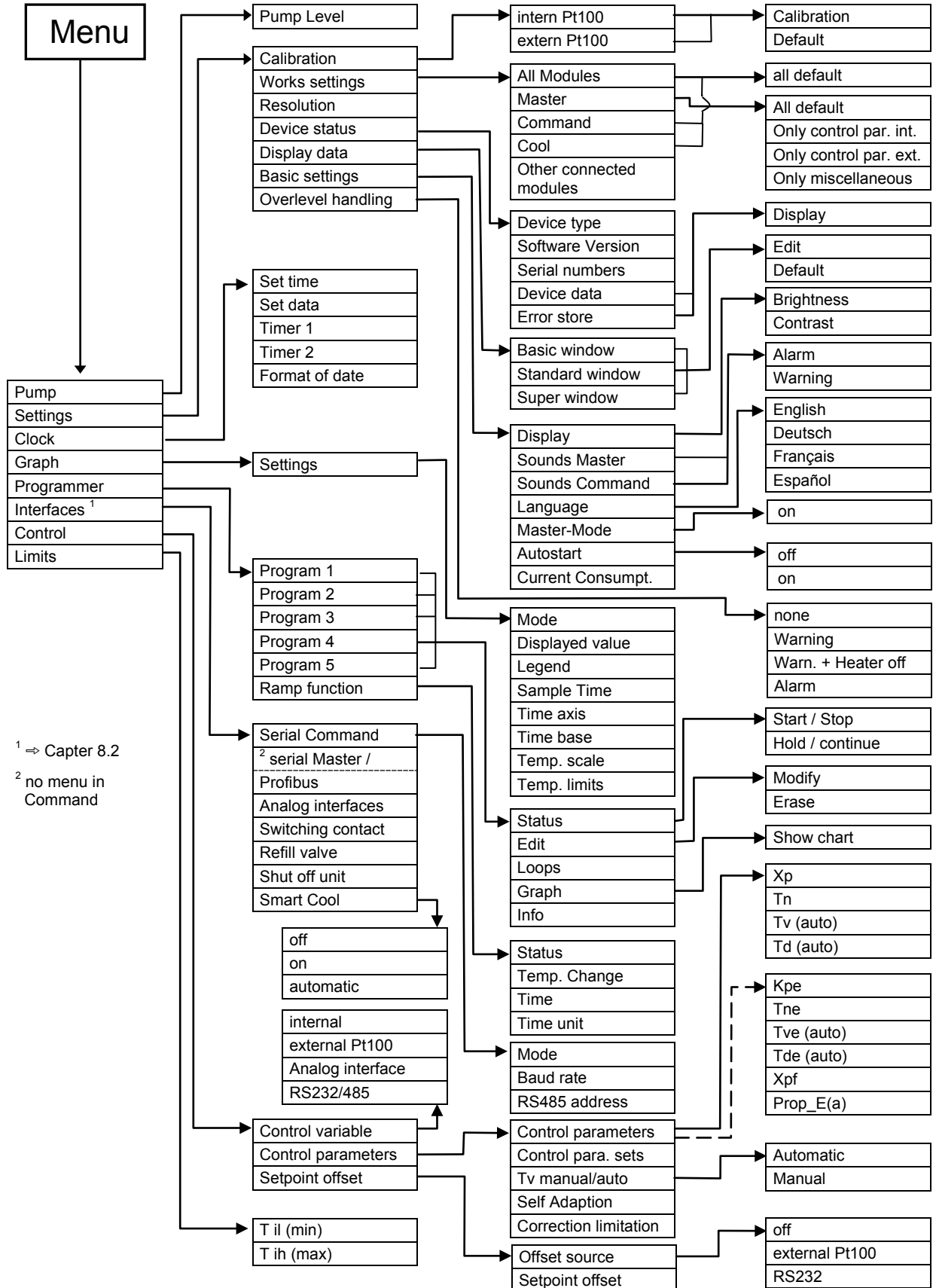

<sup>1</sup> ⇒ Capter 8.2

<sup>2</sup> no menu in Command

**7.6.1 Basic settings and branching to submenus (Master)**

Master; Main level

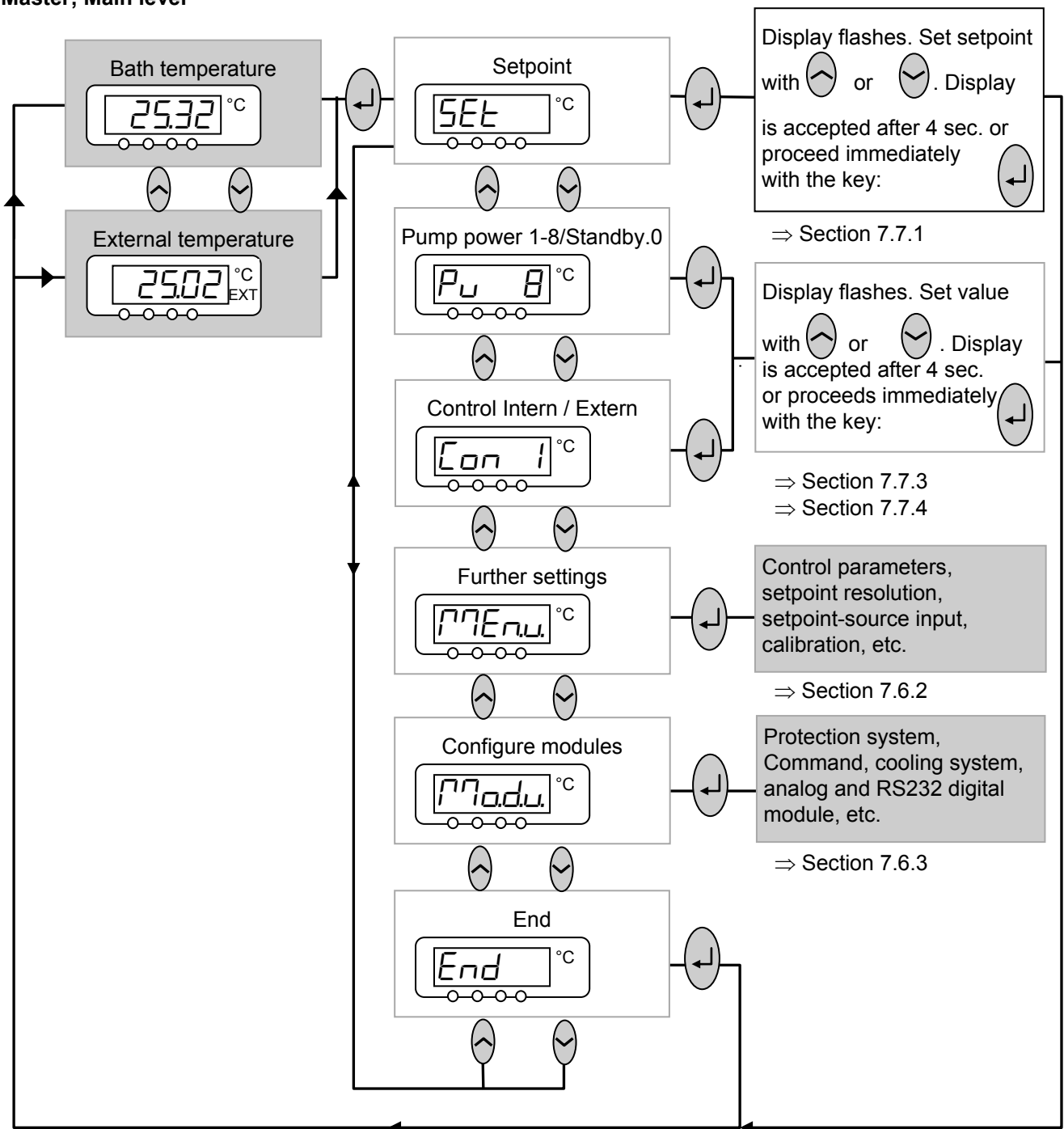

2 dots in the display, e.g. *nnEnu.*, indicate that a submenu follows.

3 dots in the display, e.g. *nnadu.*, indicate that a module submenu follows.

### 7.6.2 Submenu *PARAM* (Master): Branching to further submenus

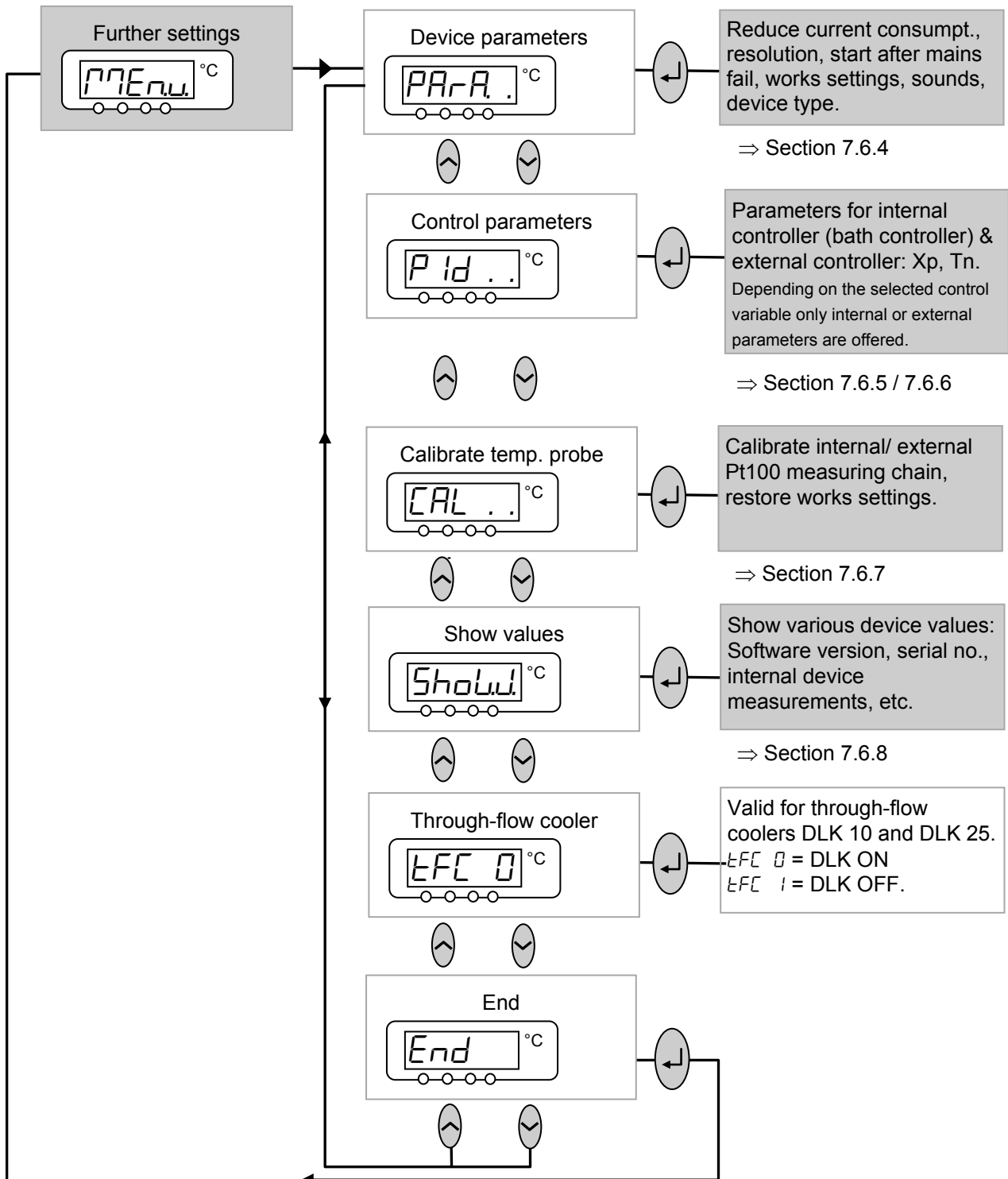



**7.6.3 Submenu *Produ* (Master): Configuration of modules**

Module/component-specific possible settings are only shown, when the hardware is connected.

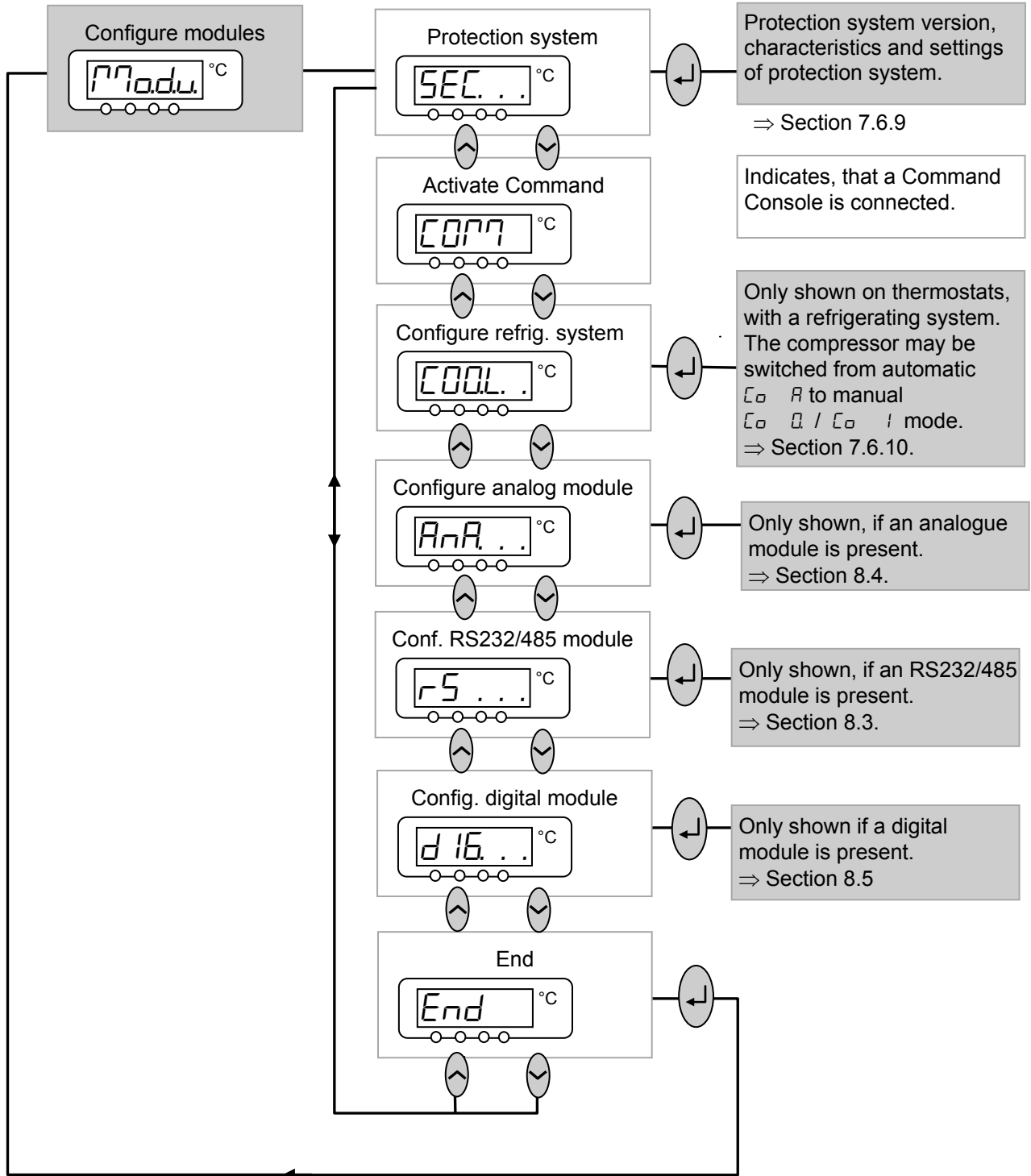

### 7.6.4 Submenu *PARA* → *PARA* (Master): Configuration of device parameters

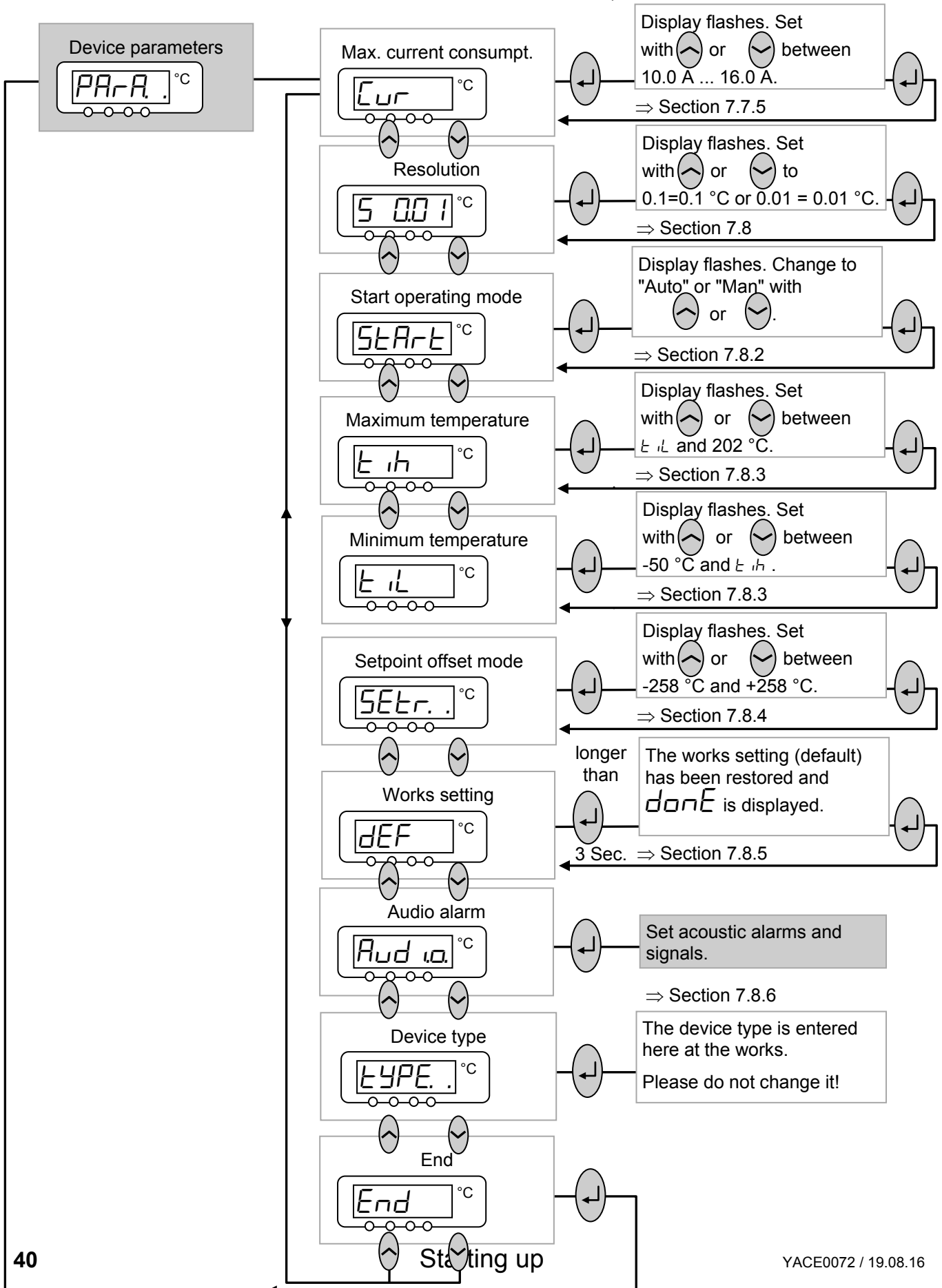

**7.6.5 Submenu  $\overline{P} \overline{I} d \dots \rightarrow P \overline{I} d \dots$  (Master): Setting internal control parameters**

You only obtain the following possible settings when the control variable is set to "Internal" ( $\Rightarrow$  7.7.4). See also ( $\Rightarrow$  7.6.6).

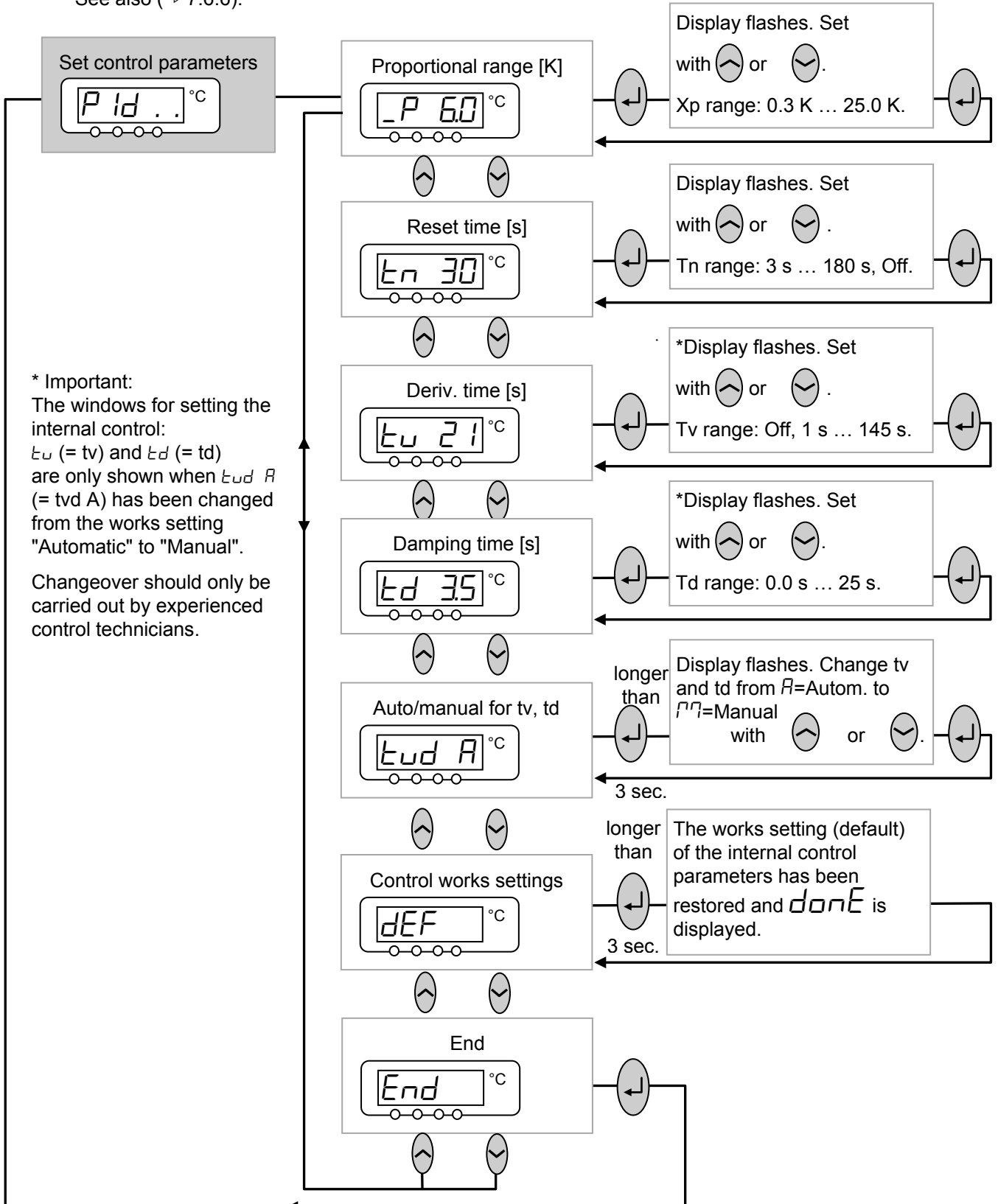

### 7.6.6 Submenu $\overline{P} \overline{I} \overline{d} \dots$ (Master): Setting external control parameters

You only obtain the following possible settings when the control variable is set to "External" ( $\Rightarrow$  7.7.4).  
See also ( $\Rightarrow$  7.6.5).

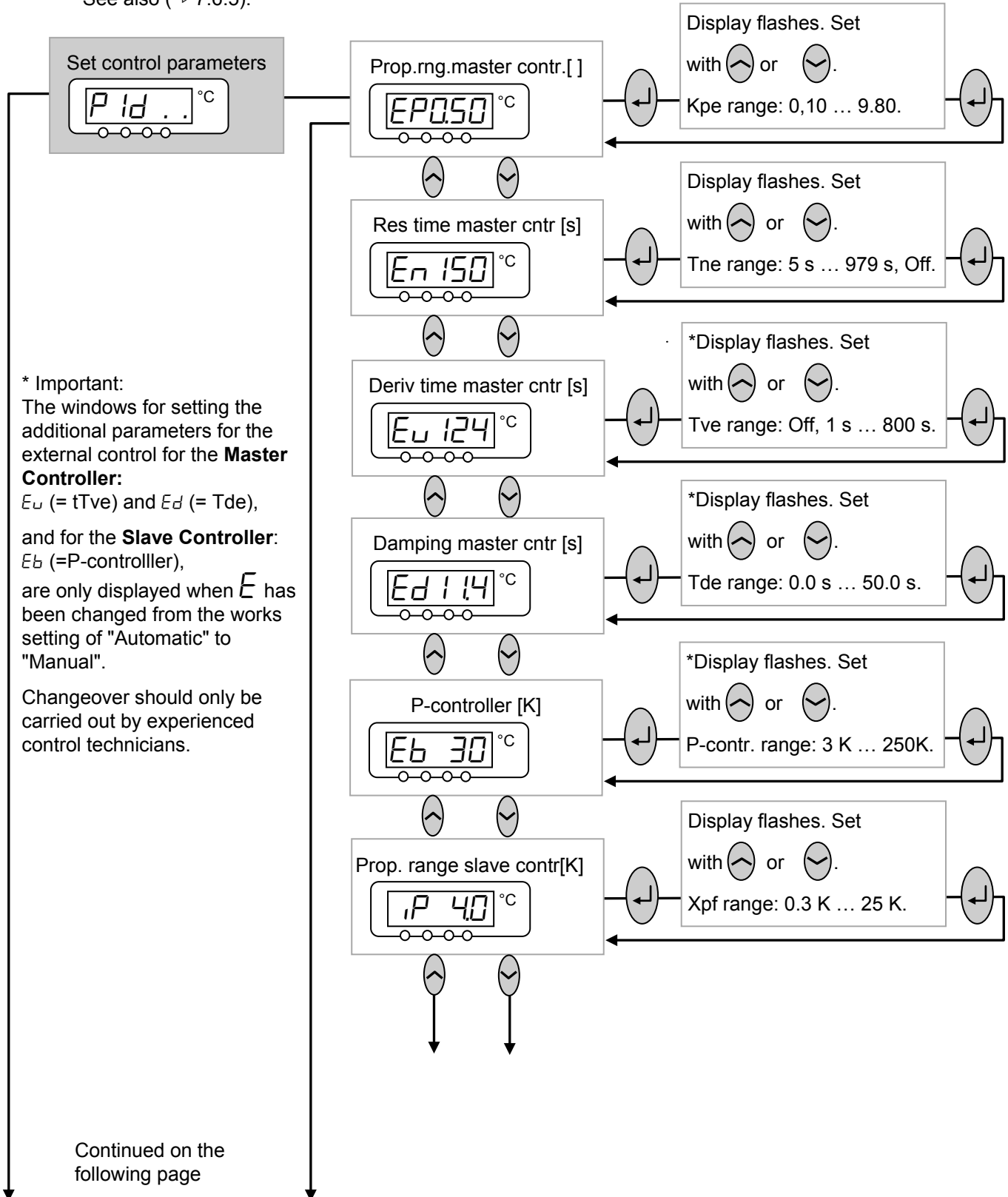

Continuation of submenu  $\overline{\overline{E}} \rightarrow P Id . .$  (Master): Setting external control parameters

Return to the previous page

\* Important:  
The windows for setting the additional parameters for the external control for the **Master Controller**:  $E_u$  (= Tve) and  $E_d$  (= Tde), and for the **Slave Controller**:  $E_b$  (= P-controller), are only displayed when  $E$  has been changed from the works setting of "Automatic" to "Manual".  
Changeover should only be carried out by experienced control technicians.

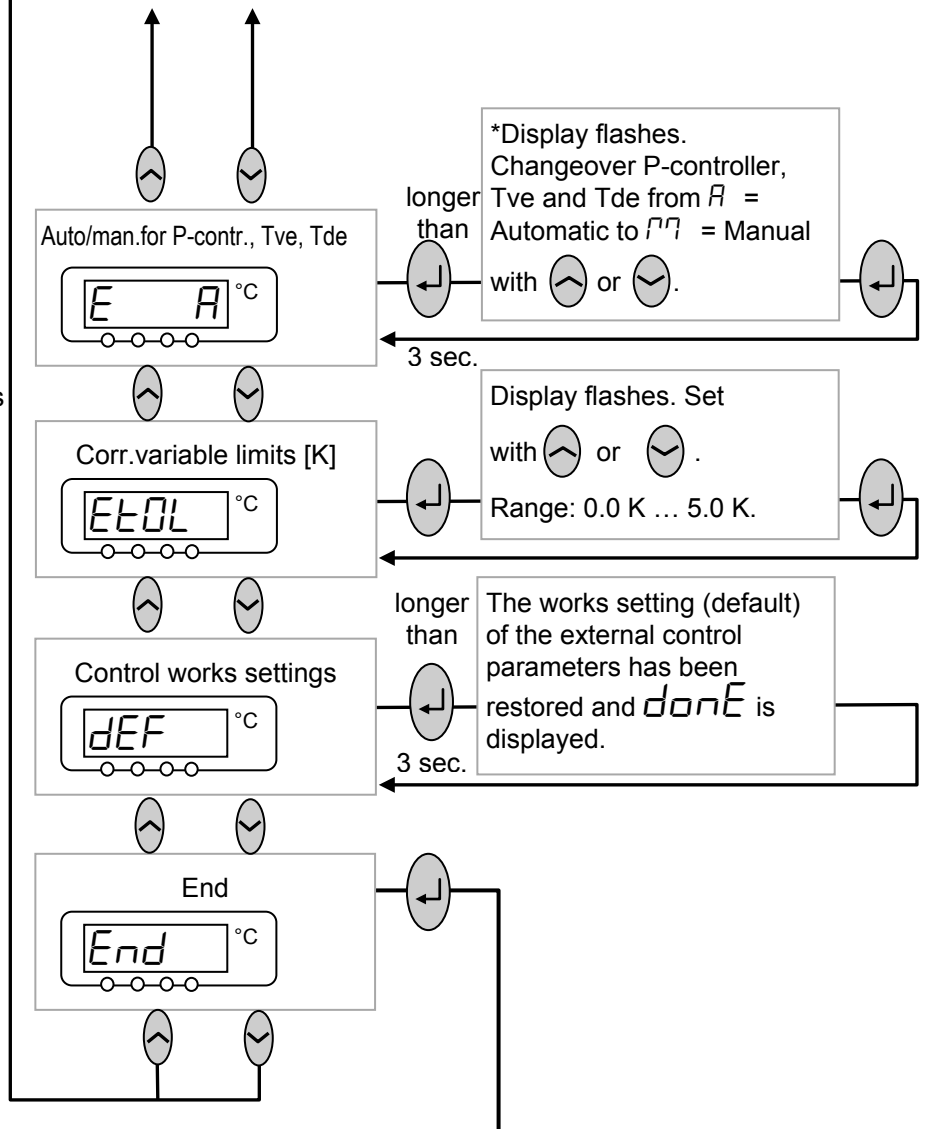

### 7.6.7 Submenu $\overline{P} \overline{7} \overline{E} \overline{n} \overline{u} \rightarrow \overline{CAL} \dots$ (Master): Calibrating internal and external Pt100 temperature probe measuring chains (adjustment)

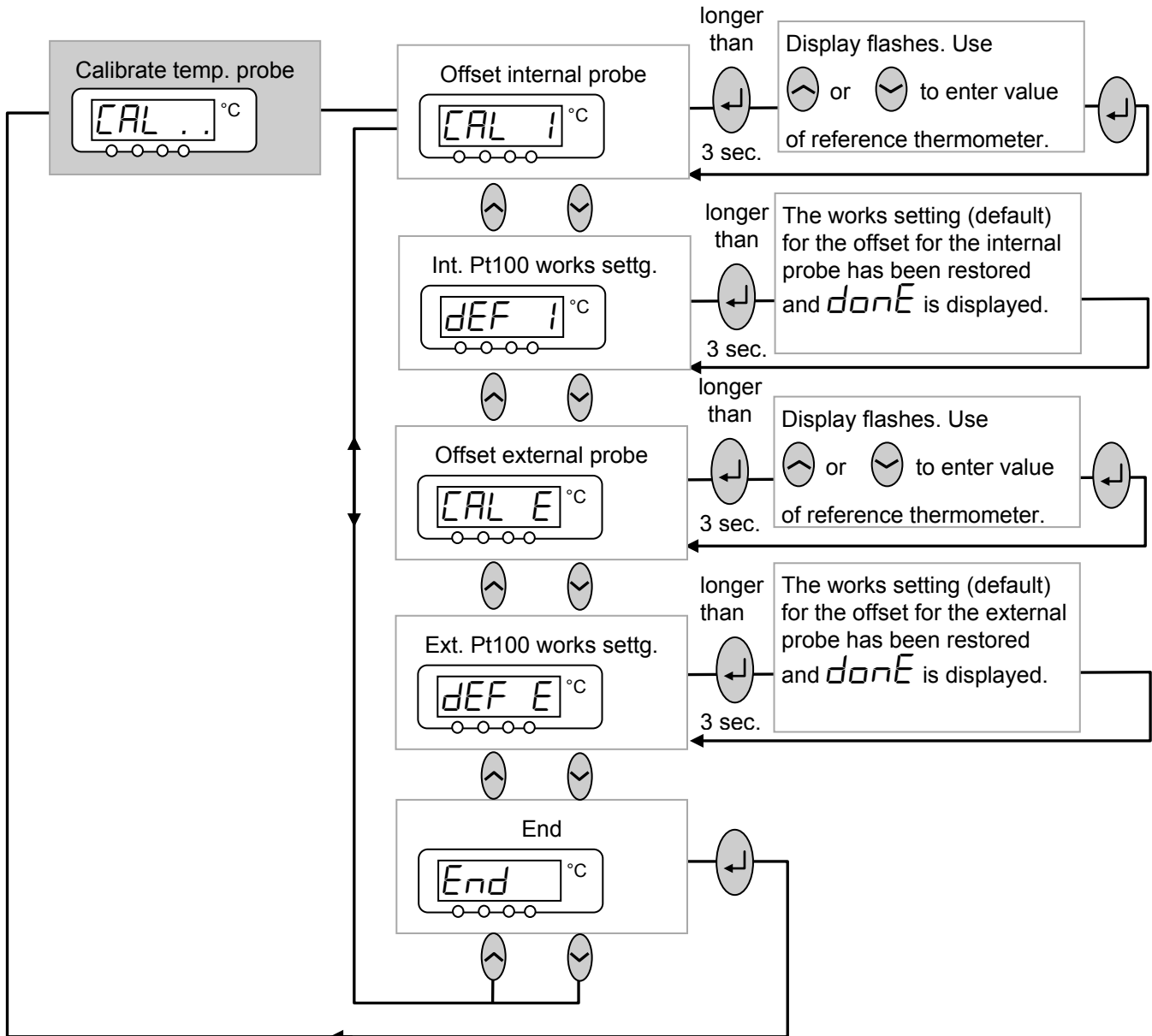

7.6.8 Submenu *Prüfung* → *ShoW* (Master): Displaying internal values of the thermostat

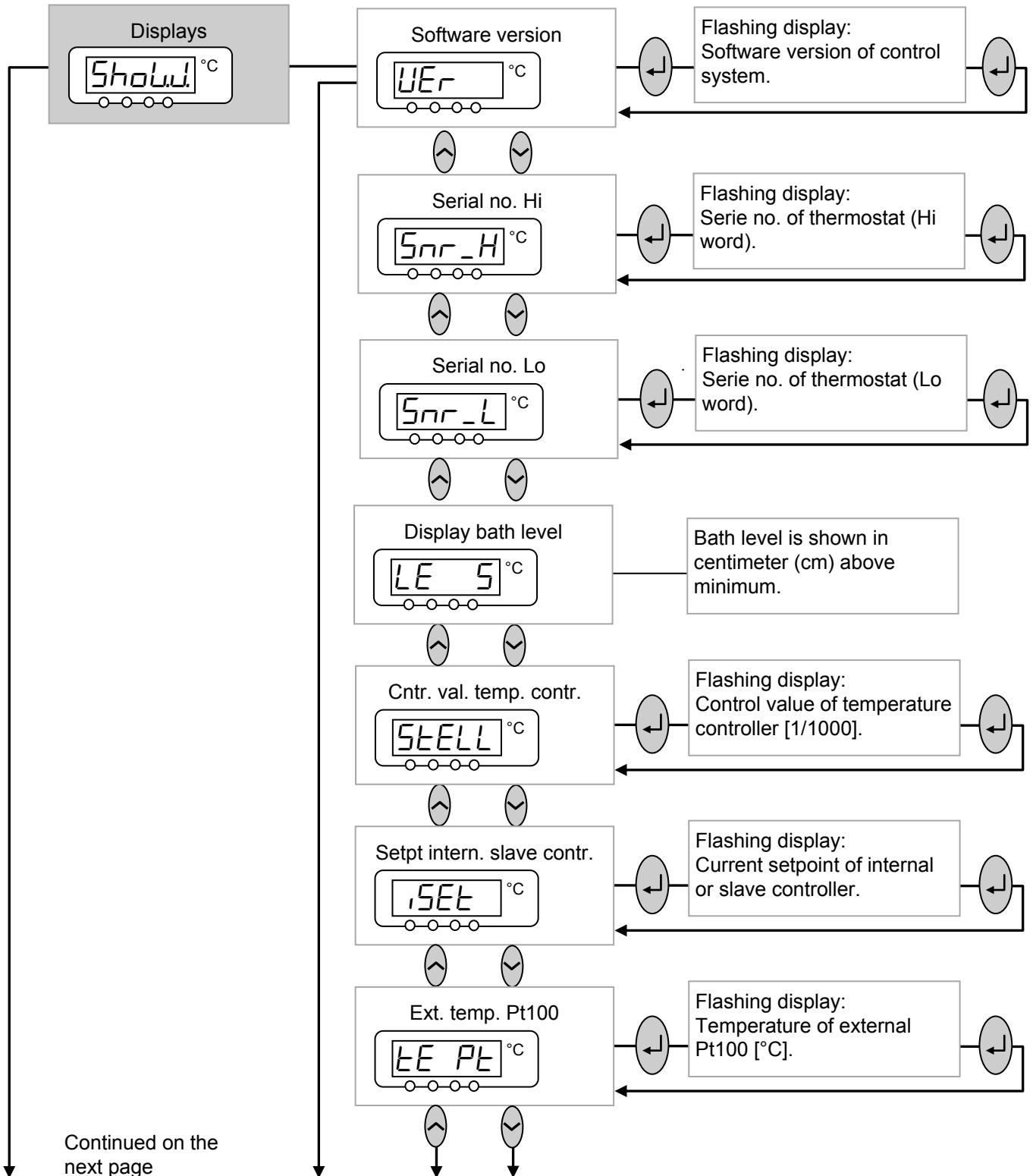

### Continuation of submenu *Show.U*: Displaying internal values of the thermostat

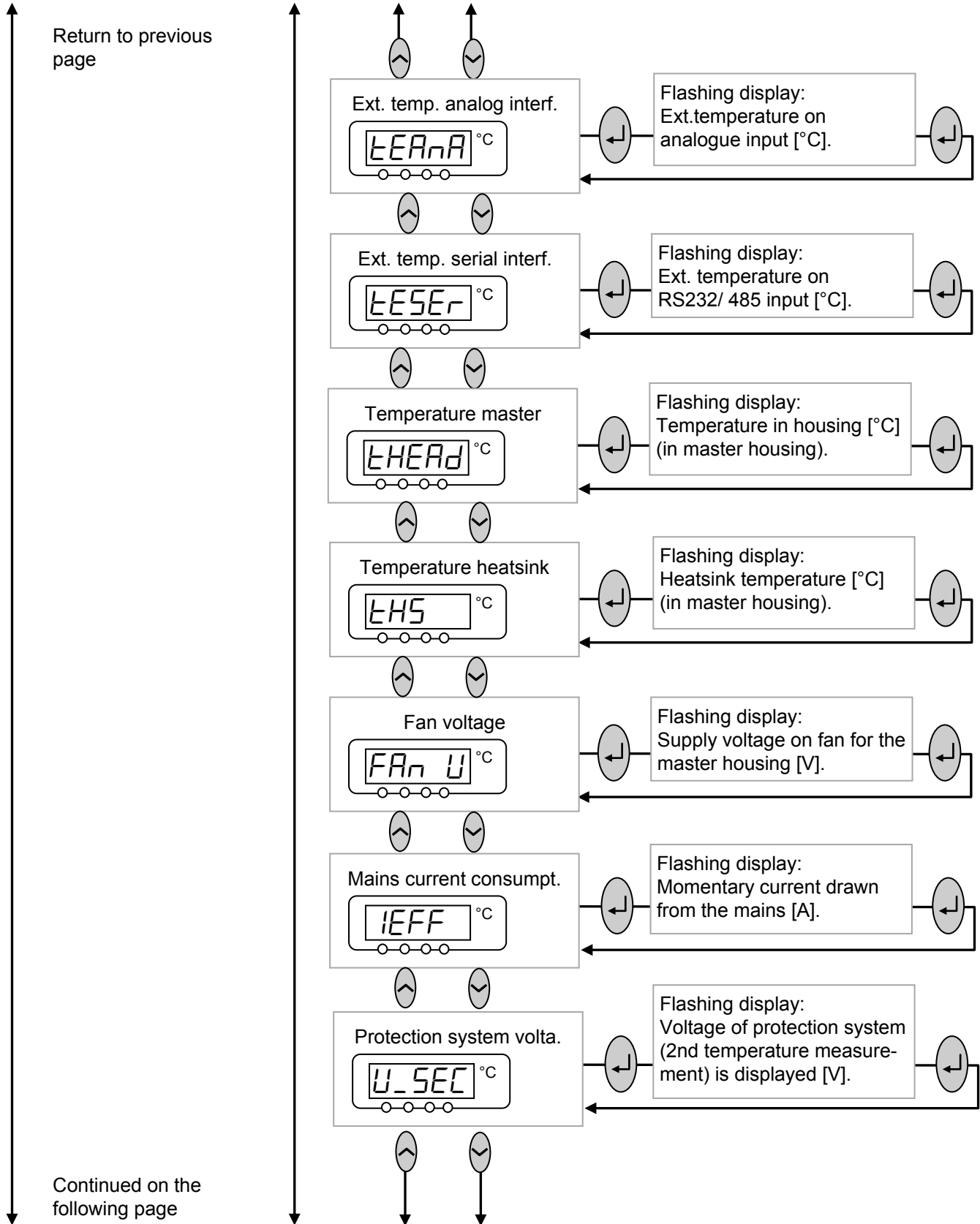



Continuation of submenu *ShoLU*: Displaying internal values of thermostat

Return to previous page

24V supply voltage

Flashing display: Actual value of 24 V supply voltage [V].

Pump power

Flashing display: Momentary pump power consumption [W].

Pump current

Flashing display: Momentary pump current consumption in [A].

Pump speed

Flashing display: Momentary pump speed in [rpm].

Mains frequency

Display of mains frequency: 50 = 50 Hz, 60 = 60 Hz.

Mains voltage

Flashing display: Mains voltage in percentage of nominal voltage.

Counter operating hours

Flashing display: Counter operating hours Master complet.

Counter operating hours

Flashing display: Counter operating hours pump.

End

Starting up

### 7.6.9 Submenu *Modu* → *SEC.* . . (Master): Safety system settings

The safety modul takes care of all safets related tasks. It is integrated in the Master and it cannot be plugged in and out as other modules can. Some settings as adjusting the acoustic alarm level of messages or to view parameters ( *SHOUU* ) can be accessed over the Master settings as well.

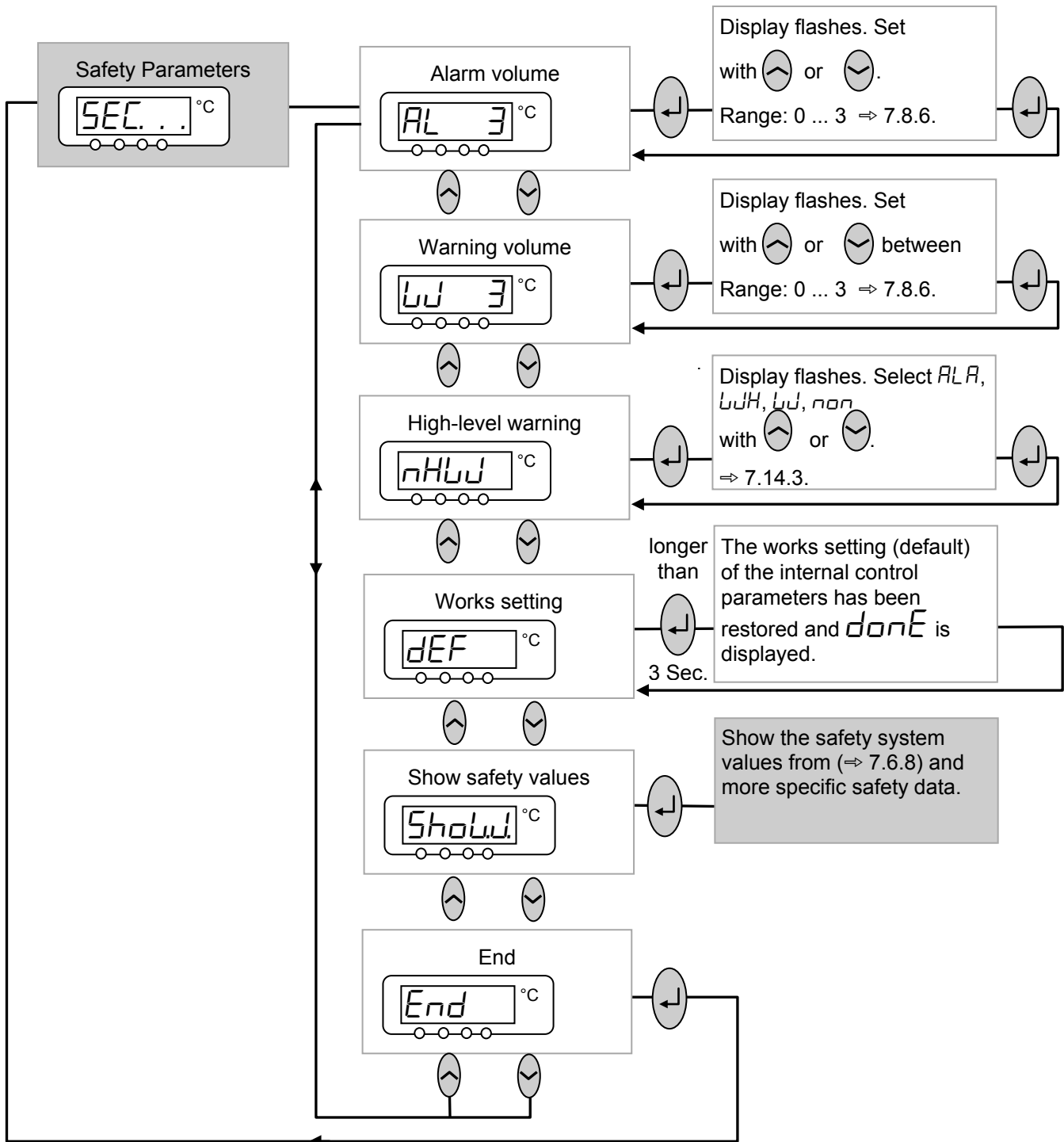

## 7.6.10 Submenu *Proline* → *COOL.* (Master): Refrigerating system settings

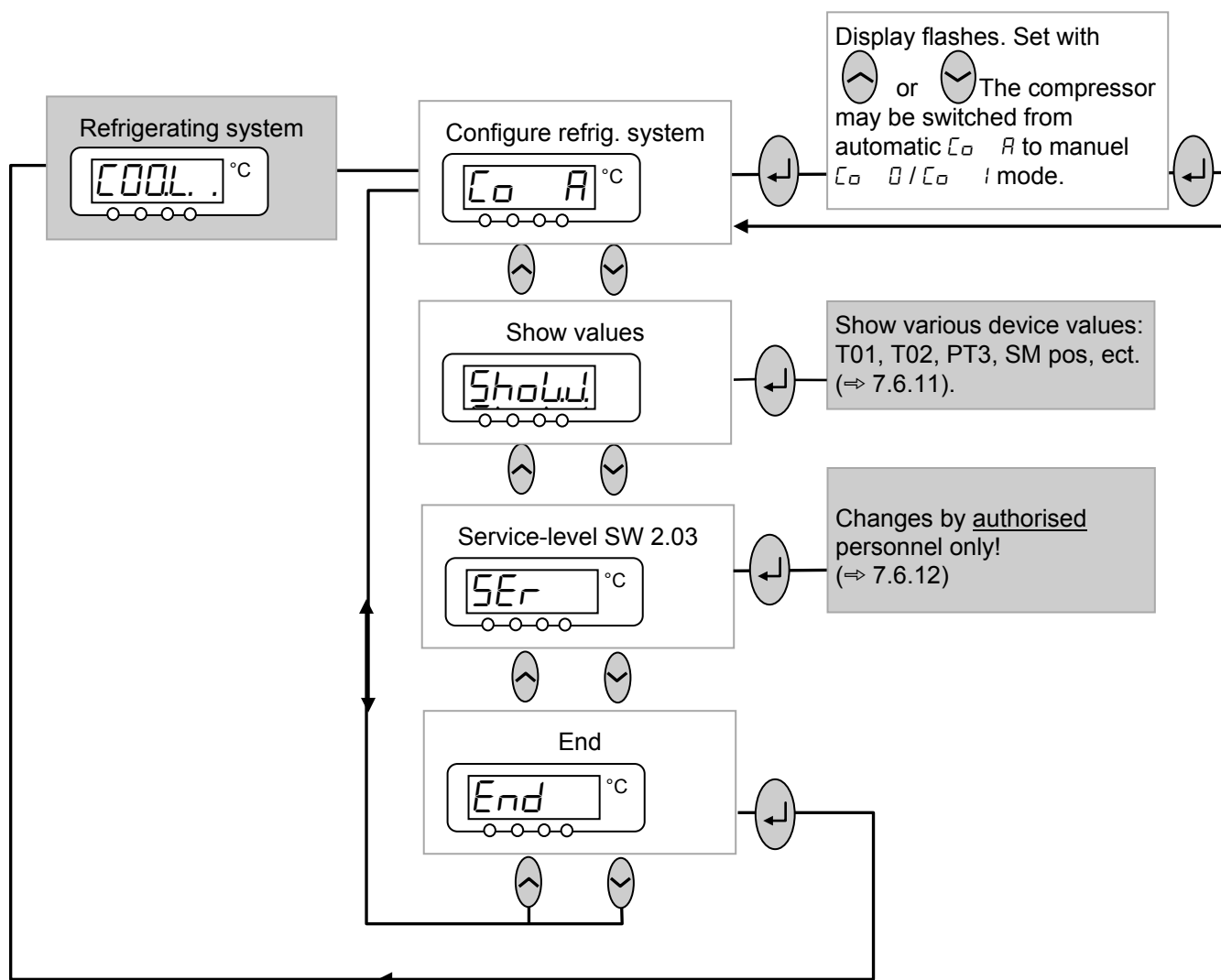

### 7.6.11 Submenu *Modu* → *COOL.* → *ShowL* (Master): Displaying refrigerating system settings

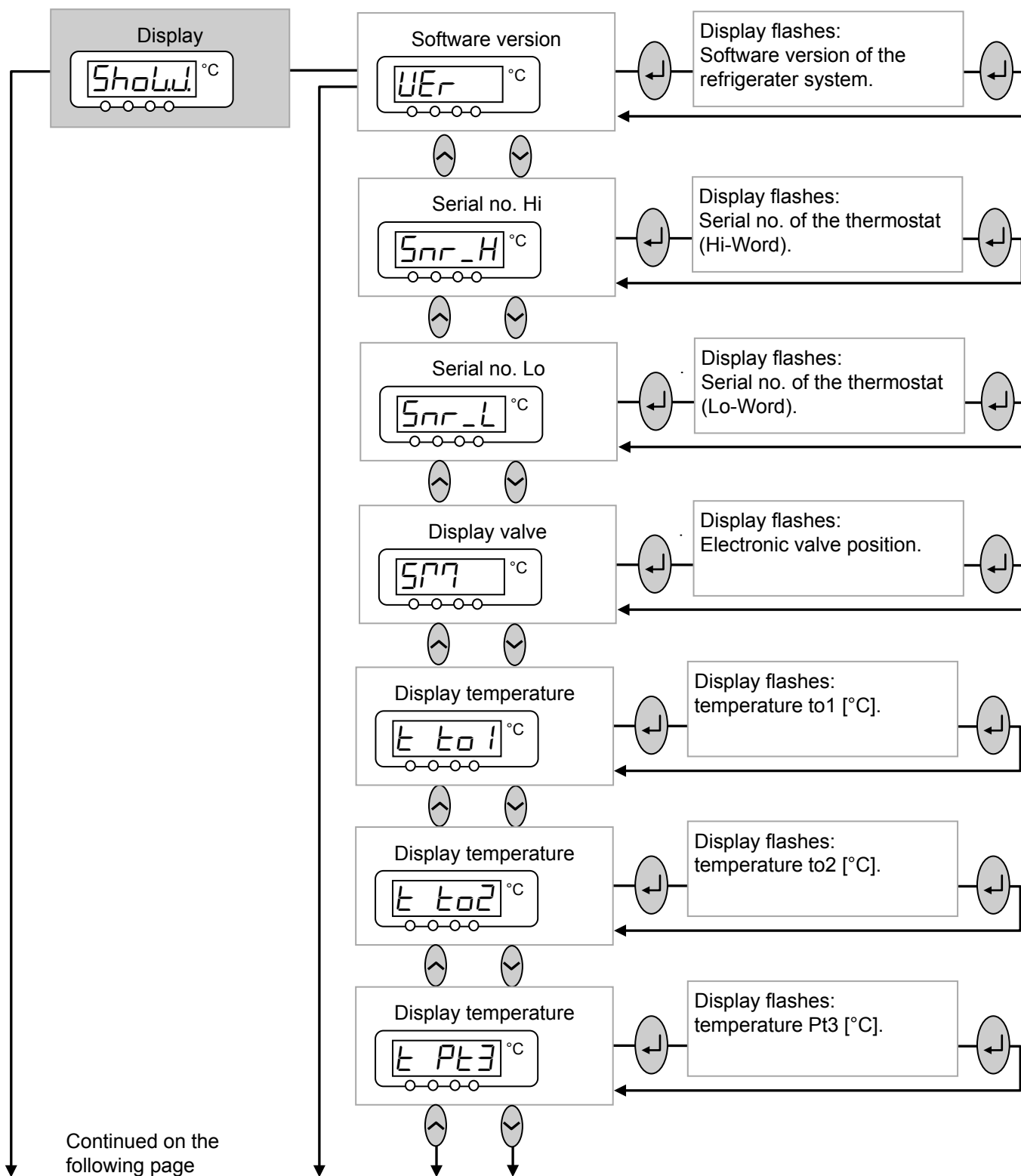

Continuation of submenu *Modu* → *COOL.* → *Show* (Master): Displaying refrigerating system settings

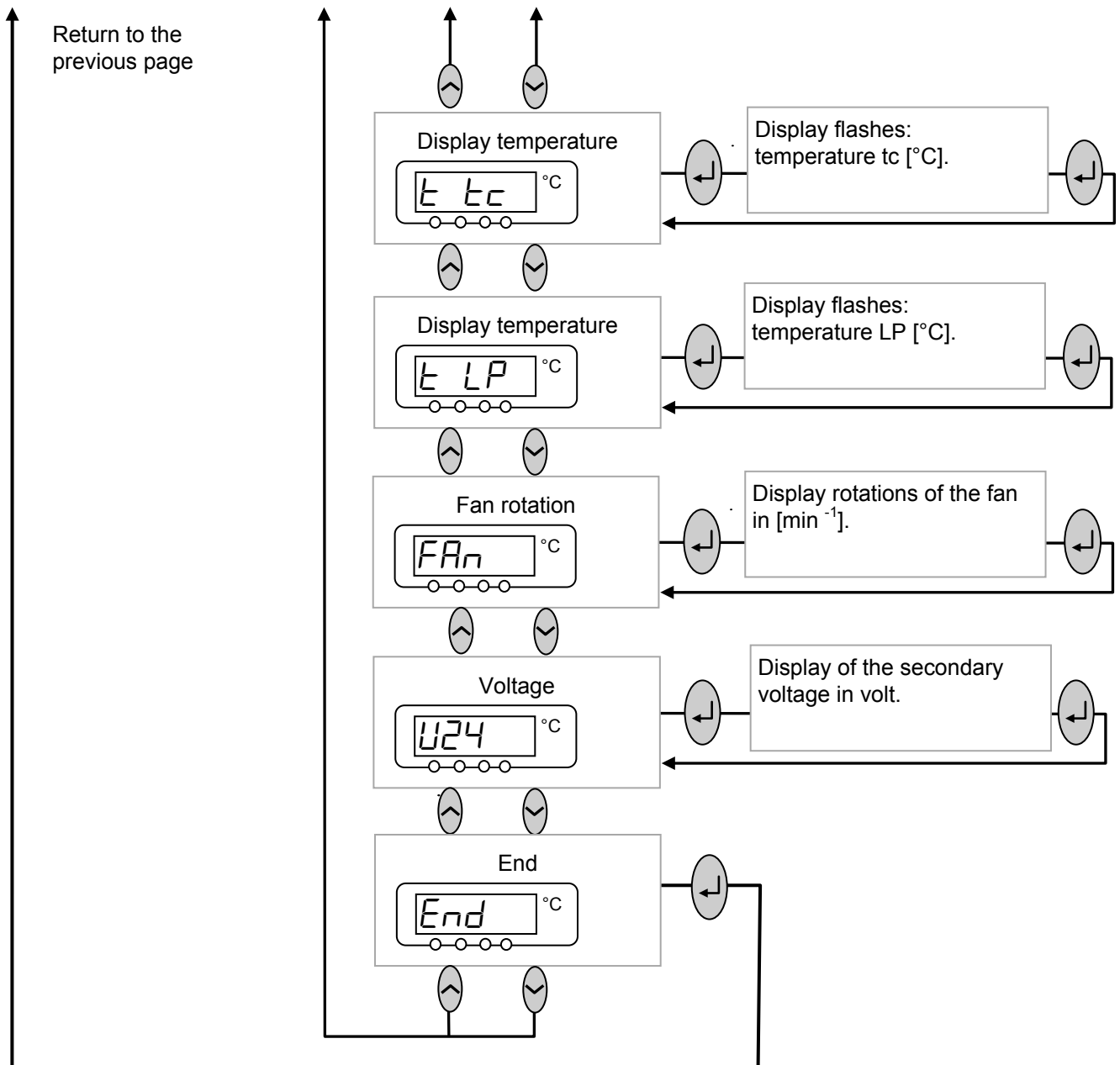



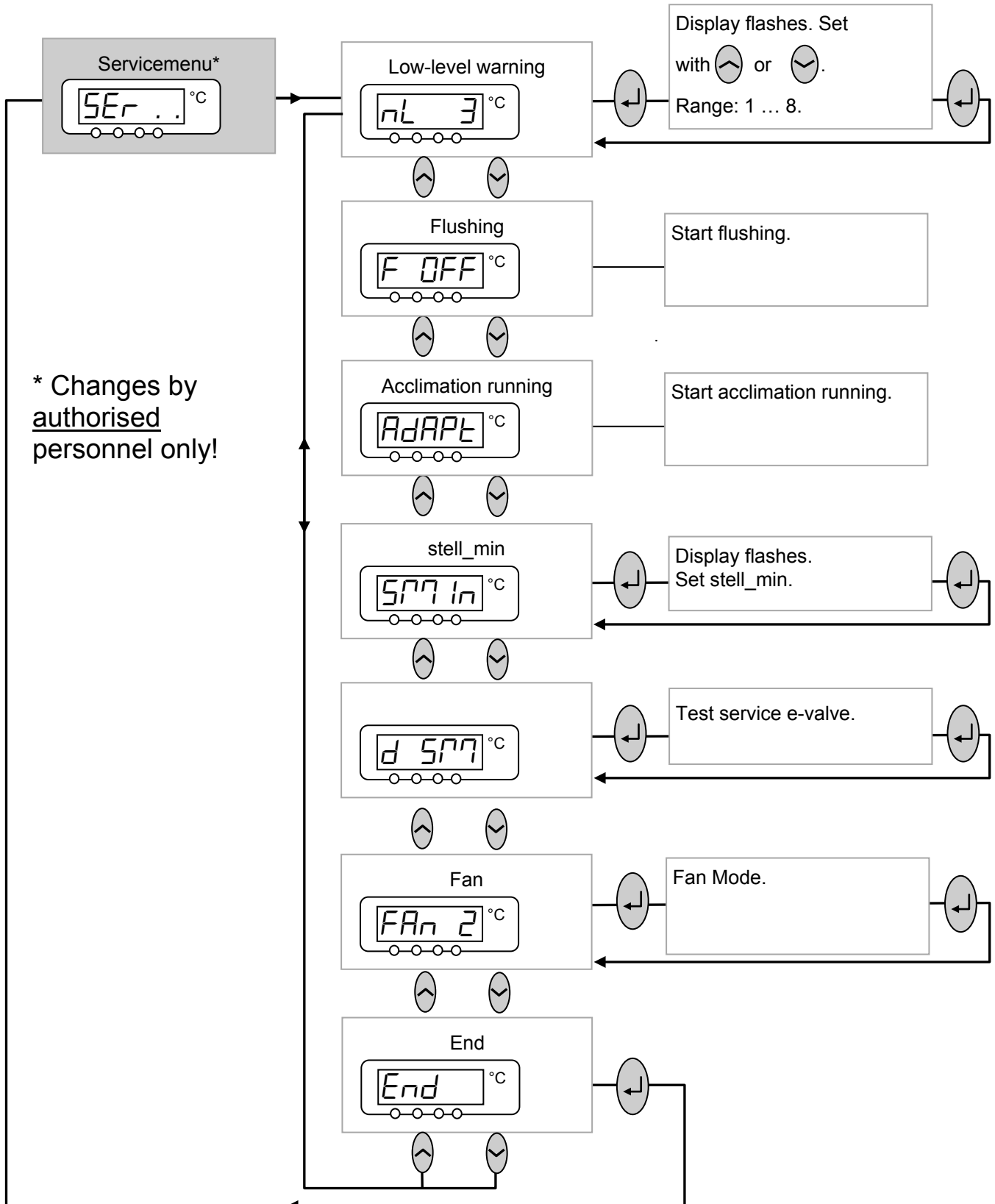



### 7.6.12 Submenu *Modu* → *COOL.* → *Ser . .* (Master): Displaying refrigerating system settings



## 7.7 Important settings

### 7.7.1 Temperature setpoint setting

The setpoint is the temperature, which the thermostat should reach and maintain constant.

Master (main level)	<i>SEt</i>
   or  Wait 4 seconds or  	<ul style="list-style-type: none"> <li>- Press key until <i>SEt</i> (Setpoint) appears.</li> <li>- Press, display flashes.</li> <li>- Enter the setpoint with the two keys (⇒ Section 7.4.1 General key functions and pilot lamps).</li> <li>- Display flashes 4 seconds → new value is automatically accepted, <b>or</b> value is accepted immediately with Enter key.</li> <li>- For safety reasons the setpoint can only be set up to 2 °C above upper limit of the operating temperature range for the relevant device type.</li> <li>- In the following cases, the manual setpoint entry is blocked: Setpoint is taken from the analog module, from the programmer in the Command Console or via the serial interface.</li> <li>- When the setpoint temperature is to be lowered, it may take up to one minute before the blue LED  lights.</li> </ul>

Command
T<sub>set</sub> or T<sub>fix</sub>

Enter new setpoint:

123,45

Min: -40.00°C Max: 202.00°C

1	2	3	4	5
6	7	8	9	0

- or the soft key T<sub>set</sub> opens the setpoint window.
- **123.45** is the setpoint, which is still active. The upper and lower limit temperatures are displayed (device-specific values).

There are three different possible entry methods:

1. Change the value with the or keys. First, you vary the 1/10 °C values. If you hold the key pressed longer, then full degrees change.
2. Enter the complete number with the numerical duo keys and the key for the negative sign and decimal point.
3. Using or , move the flashing cursor line to the decimal place which you would like to change and then change it with or .

- Confirm the value with or quit the window with without having made any changes.

Two other ways of entering the setpoint:

- With the soft key T<sub>fix</sub> open the window shown on the left.
- The setpoints, which you last entered, are shown in the right-hand column. In the illustrated screen, the last setpoint was 80.0 °C.
- To accept an earlier setpoint, enter the right-hand column with and select the desired value with , then accept it with or cancel with .
- In the left-hand column setpoint temperatures, which are to be used frequently, can be defined as "fixed settings".

Fixed settings	Recent setpoints
0.00°C	80.00°C
0.00°C	-35.50°C
0.00°C	20.00°C
0.00°C	38.00°C
0.00°C	-35.70°C
0.00°C	0.00°C
0.00°C	0.00°C
0.00°C	0.00°C

Pump	Menu	End	T <sub>set</sub>	Edit
------	------	-----	------------------	------



Enter new setpoint:

# 123.45

Min: -40.00°C Max:202.00°C

1	2	3	4	5
6	7	8	9	0

- Select desired position with the cursor keys (black background).
- With the soft key Edit open the window shown on the left.
- Enter fixed temperature setpoint as described above and accept into the list with or cancel with .
- Select and accept values from the list of fixed settings as described above for the "Recent setpoints".

### 7.7.2 Displaying the actual external temperature

With all Proline Thermostats an external temperature probe can be connected, which for example...

1. ...can be used as an independent temperature measurement channel,
2. ...can be used as the controlled variable for the bath temperature in applications with a noticeable temperature gradient (between the internal bath temperature and an external load). The setup is described in Section 7.7.4. With the function described in the following, you only change over the display.



- External actual temperatures can also be read in by interface modules (⇒ 8).

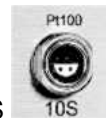

Connection of the external Pt100 to the Lemo socket 10S

Contact on socket 10S

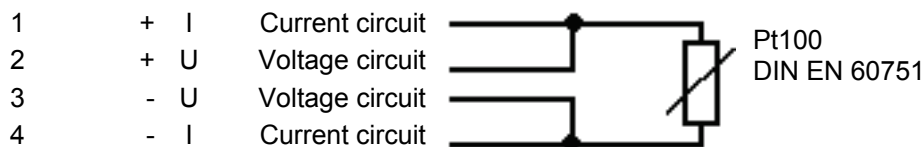

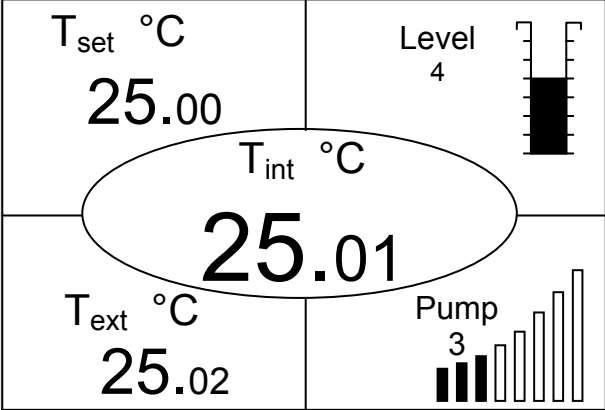

- Plug: 4-pole Lemos for Pt100 connection (Order No. EQS 022).
- Use screened connecting leads. Connect screen to plug case.





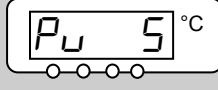





<p><b>Master</b></p> <p>↑ or ↓</p> 	<p><b>EXT</b></p> <ul style="list-style-type: none"> <li>– Switches to the actual-value display of the external temperature probe (or to the actual value received from an interface module (⇒ 7.7.4)).</li> <li>– <b>EXT</b> is lit in green next to the row of figures.</li> <li>– If no external Pt100 probe is connected, ----- is displayed.</li> </ul>
<p><b>Command</b></p>  <p>Pump   Menu   Screen   T<sub>set</sub>   T<sub>fix</sub></p>	<p><b>T<sub>ext</sub></b></p> <ul style="list-style-type: none"> <li>– Provided an external temperature probe is connected, its value is displayed in the lower left part of the standard and super windows (applies to the works setting for the window partitioning).</li> <li>– <b>External actual temperatures can also be read in via interface modules (⇒ 8).</b></li> </ul>

### 7.7.3 Setting pump power or standby

With the Proline Varioflex pump, eight pump levels are available, with which the bath circulation, flow rate and pressure, the noise generated and the mechanical heat input can be optimized. This is particularly advantageous with coolers. With smaller coolers (e.g. RP845) without an external load, Power Level 3 to 4 is practicable and sufficient.

<p><b>Master</b></p> <p>← and 1 x ↓</p>  <p>↓</p> <p>↑ or ↓</p>	<p><b>P<sub>U</sub></b></p> <ul style="list-style-type: none"> <li>– Call pump power levels display <b>P<sub>U</sub></b>.</li> <li>– The current pump level is displayed (here 5).</li> <li>– The pump levels display flashes.</li> <li>– Select pump level (pump speed = pump power): 1 to 8 for pump operation. Pump responds immediately!</li> <li>– 0 activates the standby function (pump, heater and refrigerating machine are deactivated).</li> </ul>
--	---

Wait 4 seconds or  – Display flashes 4 s → new value is automatically accepted, **or**  
 – value is immediately accepted with Enter key.

Command	Pump Level
<div style="border: 1px solid black; padding: 5px; display: flex; align-items: center;"> <div style="border: 1px solid black; padding: 2px; margin-right: 5px;">Pump Level</div> <div style="border: 1px solid black; padding: 2px;">                     Level 8                      Level 7                      Level 6  <b>Level 5</b>                      Level 4                      Level 3                      Level 2                      Level 1                 </div> </div> <div style="display: flex; justify-content: space-between; margin-top: 5px;"> <span>Pump</span> <span>Menu</span> <span>End</span> <span>T<sub>set</sub></span> <span>T<sub>fix</sub></span> </div> <div style="text-align: center; margin-top: 10px;">  +  </div>	<ul style="list-style-type: none"> <li>– Open the device parameter menu via the soft key  <span style="border: 1px solid black; padding: 2px;">Menu</span>.</li> <li>– Change from <b>Pump</b> → <b>Pump Level</b> using .</li> <li>– With  or  you enter the illustrated window. <b>Level 5</b> is active.</li> <li>– Select another pump level with  or  and confirm with  or <span style="border: 1px solid black; padding: 2px;">End</span>,</li> <li>– or quit the window with  without making any changes.</li> </ul> <p><b>Standby activation</b></p> <ul style="list-style-type: none"> <li>– Standby activation (Pump, heater and refrigerating machine are deactivated when the green LED in the lower part of the key is lit).</li> </ul>





Please exercise caution when thermostat is in standby mode 7.12. The following settings/ actions may start the thermostat unintentionally from the standby mode:

- A previously activated timer mode (⇒ 7.11), because a started time continues to run.
- "Start" command via interfaces (⇒ 8).

**7.7.4 Activating external control**

An external temperature probe can be connected to the Proline Thermostats. How this is done is explained in Section 7.7.2. If the bath temperature is to be controlled using this sensor instead of the internal sensor, the setting can be made here.

Furthermore, control can also occur based on the signal from the analog or serial module (⇒ 4.8).

Master	<b>Con</b>
<div style="text-align: center; margin-bottom: 10px;">  and 2 x  </div> <div style="border: 1px solid gray; padding: 5px; width: fit-content; margin: 0 auto;"> <div style="border: 1px solid black; padding: 2px; display: flex; align-items: center;"> <span style="font-family: monospace; font-size: 1.2em;">Con</span> <span style="margin-left: 5px;">1 °C</span> </div> <div style="display: flex; justify-content: center; gap: 5px; margin-top: 2px;"> <span style="width: 10px; height: 10px; border-radius: 50%; background-color: white; border: 1px solid black;"></span> <span style="width: 10px; height: 10px; border-radius: 50%; background-color: white; border: 1px solid black;"></span> <span style="width: 10px; height: 10px; border-radius: 50%; background-color: white; border: 1px solid black;"></span> </div> </div>	<p>Call the source selection for the control <b>Con</b>.</p> <ul style="list-style-type: none"> <li>– The momentary setting for the source is displayed,</li> <li>– here <i>i</i> for internal, because control takes place using the temperature signal from the internal temperature probe.</li> </ul>

- The source display flashes.





Change temperature probe source:

- *I* for the internal probe,
- *EP* only when an external probe is connected,
- *EA* only when an analog module is connected and configured,
- *ES* only when a serial module is connected and is continuously receiving actual values from a PC.
- Display flashes 4 s → new value is automatically accepted, **or**
- Value is immediately accepted with Enter key.
- If *EP* *EA* or *ES* has been selected, then the green LED indicates that the control has regulated to the external temperature signal.

Command	Control Variable
<div style="border: 1px solid black; padding: 5px; margin-bottom: 5px;">Control Variable</div> <div style="border: 1px solid black; padding: 5px; margin-bottom: 5px;"> <div style="background-color: black; color: white; padding: 2px;">Internal</div>                     External Pt100                      Analog module                      Digital module                 </div> <div style="display: flex; justify-content: space-between; border-top: 1px solid black; padding-top: 5px;"> <span>Pump</span> <span>Menu</span> <span>End</span> <span>T<sub>set</sub></span> <span>T<sub>fix</sub></span> </div>	<ul style="list-style-type: none"> <li>- Open the device parameter menu with the soft key  <span style="border: 1px solid black; padding: 2px;">Menu</span> .</li> <li>- With the cursor keys, change further to → <span style="background-color: black; color: white; padding: 2px;">Control</span> → <span style="background-color: black; color: white; padding: 2px;">Control Variable</span> .</li> <li>- <span style="background-color: black; color: white; padding: 2px;">Internal</span> is currently active.</li> <li>- Select other control variables (only displayed when present) with  or  and confirm with  or <span style="border: 1px solid black; padding: 2px;">End</span> ,</li> <li>- or quit the window with  without making any changes.</li> </ul>

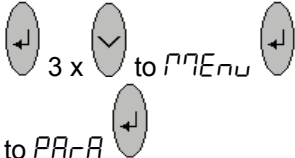
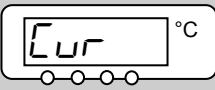
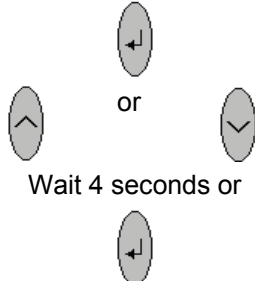
### 7.7.5 Current consumption from the mains

If your mains fuse is rated below 16 A, the current consumption can be reduced in steps from 16 A to 10 A using this function. Of course, the maximum heating power of 3.5 kW is then also reduced accordingly. Take into account whether other loads are still connected to the fused circuit or whether your Proline Thermostat is the only load.

<p><b>Master</b></p> <p style="text-align: right; font-size: 1.2em;"><i>Cur</i></p> <p>                3 x to <i>TEMP</i>               to <i>PARA</i> </p> <div style="border: 1px solid gray; padding: 5px; margin: 5px 0; text-align: center;">  </div> <p>                or                           Wait 4 seconds or         </p>	<ul style="list-style-type: none"> <li>- Call current consumption <i>Cur</i>.</li> <li>- The present setting is displayed.</li> <li>- The current consumption is shown flashing: e.g. <i>16.0</i> A.</li> <li>- Set the required maximum current consumption (in A).</li> <li>- Display flashes 4 s → new value is automatically accepted, <b>or</b></li> <li>- Value is immediately accepted with the Enter key.</li> </ul>															
<p><b>Command</b></p> <div style="border: 1px solid black; padding: 5px; margin-bottom: 5px;"> <p>Display</p> <p>Sounds Master</p> <p>Sounds Command</p> <p>Language</p> <p>Master Mode</p> <p>Autostart</p> <p style="border: 1px solid black; display: inline-block; padding: 2px;">Current consumpt.</p> </div> <div style="border: 1px solid black; padding: 5px; margin-bottom: 5px; text-align: center;"> <p style="background-color: black; color: white; padding: 2px;">16.0 A</p> </div> <table border="1" style="width: 100%; border-collapse: collapse; margin-bottom: 5px;"> <tr> <td style="padding: 2px;">Pump</td> <td style="padding: 2px;">Menu</td> <td style="padding: 2px;">End</td> <td style="padding: 2px;">T<sub>set</sub></td> <td style="padding: 2px;">T<sub>fix</sub></td> </tr> </table> <div style="border: 1px solid black; padding: 10px; margin-bottom: 5px;"> <p>Max. current consumption (in A):</p> <p style="font-size: 2em; text-align: center; margin: 10px 0;"><b>16.0</b></p> <p>Min: 10.0 A    Max: 16.0 A</p> </div> <table border="1" style="width: 100%; border-collapse: collapse;"> <tr> <td style="padding: 2px;">1</td> <td style="padding: 2px;">2</td> <td style="padding: 2px;">3</td> <td style="padding: 2px;">4</td> <td style="padding: 2px;">5</td> </tr> <tr> <td style="padding: 2px;">6</td> <td style="padding: 2px;">7</td> <td style="padding: 2px;">8</td> <td style="padding: 2px;">9</td> <td style="padding: 2px;">0</td> </tr> </table>	Pump	Menu	End	T <sub>set</sub>	T <sub>fix</sub>	1	2	3	4	5	6	7	8	9	0	<p style="text-align: center; background-color: black; color: white; padding: 2px;"><b>Current Consumption</b></p> <ul style="list-style-type: none"> <li>- Open the device parameter menu via the soft key  <span style="border: 1px solid black; padding: 2px;">Menu</span>.</li> <li>- With the cursor keys change further to → <b>Settings</b> → <b>Basic settings</b> → <b>Current Consumpt.</b></li> <li>- <b>16.0 A</b> is presently active.</li> </ul> <ul style="list-style-type: none"> <li>- Open the settings window with .</li> <li>- Change the current with cursor or soft keys and accept with  or <span style="border: 1px solid black; padding: 2px;">End</span>,</li> <li>- or quit the window with  without making changes.</li> </ul>
Pump	Menu	End	T <sub>set</sub>	T <sub>fix</sub>												
1	2	3	4	5												
6	7	8	9	0												

### 7.7.6 Setting the date and time (Command)

Command					<b>Clock</b> <b>Time</b> <b>Date</b>									
Pump Settings Graph <span style="border: 1px solid black; padding: 2px;">Clock</span> Programmer Interfaces Control Limits	<div style="border: 2px solid black; padding: 5px;"> <p><b>Set time</b></p>           Set date            Timer 1            Timer 2            Format of date         </div>				<ul style="list-style-type: none"> <li>- Open the device parameter menu via the soft key  <span style="border: 1px solid black; padding: 2px;">Menu</span> .</li> <li>- With the cursor keys continue to: → <b>Clock</b> → <b>Set time</b>,</li> <li>- or to <b>Set date</b>.</li> </ul>									
<table border="1" style="width: 100%; border-collapse: collapse;"> <tr> <td style="width: 20%;">Pump</td> <td style="width: 20%;">Menu</td> <td style="width: 20%;">End</td> <td style="width: 20%;">T<sub>set</sub></td> <td style="width: 20%;">T<sub>fix</sub></td> </tr> </table>	Pump	Menu	End	T <sub>set</sub>	T <sub>fix</sub>	<ul style="list-style-type: none"> <li>- Open the settings window with  .</li> <li>- Change the time with cursor or soft keys and accept with  ,</li> <li>- or quit the window with  without making changes.</li> <li>- The date is set just the same with <b>Set date</b> .</li> <li>- The date format (Day Month Year or Month Day Year) can be set under <b>Format of date</b> .</li> </ul>								
Pump	Menu	End	T <sub>set</sub>	T <sub>fix</sub>										
<div style="border: 2px solid black; padding: 10px; width: fit-content; margin: 0 auto;">           Enter time:   <h1 style="margin: 0;">15:38:12</h1> </div>														
<table border="1" style="width: 100%; border-collapse: collapse;"> <tr> <td style="width: 20%;">1</td> <td style="width: 20%;">2</td> <td style="width: 20%;">3</td> <td style="width: 20%;">4</td> <td style="width: 20%;">5</td> </tr> <tr> <td>6</td> <td>7</td> <td>8</td> <td>9</td> <td>0</td> </tr> </table>	1	2	3	4	5	6	7	8	9	0				
1	2	3	4	5										
6	7	8	9	0										

### 7.7.7 Display resolution setting (Command)

The Command version allows for different resolutions of the displayed temperature.

Command					<b>Display resolution</b>				
Pump <span style="border: 1px solid black; padding: 2px;">Settings</span> Graph Clock Programmer Interfaces Control Limits	<div style="border: 2px solid black; padding: 5px;">           Calibration            Works settings  <p><b>Resolution</b></p>           Device status            Display data            Basic settings            Overlevel handling         </div>				<ul style="list-style-type: none"> <li>- Open the device parameter menu via the soft key  <span style="border: 1px solid black; padding: 2px;">Menu</span> .</li> <li>- With the cursor keys continue to → <b>Settings</b> → <b>Display resolution</b> .</li> </ul>				
<table border="1" style="width: 100%; border-collapse: collapse;"> <tr> <td style="width: 20%;">Pump</td> <td style="width: 20%;">Menu</td> <td style="width: 20%;">End</td> <td style="width: 20%;">T<sub>set</sub></td> <td style="width: 20%;">T<sub>fix</sub></td> </tr> </table>	Pump	Menu	End	T <sub>set</sub>	T <sub>fix</sub>				
Pump	Menu	End	T <sub>set</sub>	T <sub>fix</sub>					

<div style="border: 1px solid black; padding: 5px;"> <div style="border: 1px solid black; padding: 2px;">Resolution</div> <div style="border: 1px solid black; padding: 2px; margin-top: 5px;">                 0,1                  0,01  <b>0,001</b> </div> </div>	<ul style="list-style-type: none"> <li>- Select the desired resolution with  or .</li> <li>- Accept selection with  or <span style="border: 1px solid black; padding: 2px;">End</span> ,                      or quit the window with  without making changes.</li> </ul>
<div style="display: flex; justify-content: space-between; border-top: 1px solid black; border-bottom: 1px solid black;"> <span>Pump</span> <span>Menu</span> <span>End</span> <span>T<sub>set</sub></span> <span>T<sub>fix</sub></span> </div>	

## 7.8 Special settings

### 7.8.1 Setpoint resolution

This function enables the resolution of the setpoint T<sub>set</sub> to be increased from the standard value of 0.1 °C to 0.01 °C (only Master).

<div style="border: 1px solid black; padding: 5px;"> <p><b>Master</b> <span style="float: right; font-size: 2em;"><b>S</b></span></p> <div style="display: flex; justify-content: space-around; align-items: center;"> <div style="text-align: center;"> </div> <div style="text-align: center;"> </div> <div style="text-align: center;"> </div> </div> <p style="text-align: center;">3x to <b>PR-PR</b></p> <div style="display: flex; justify-content: space-around; align-items: center;"> <div style="text-align: center;"> </div> <div style="text-align: center;"> </div> <div style="text-align: center;"> </div> </div> <p style="text-align: center;">1x to <b>PR-PR</b></p> <div style="border: 1px solid black; padding: 5px; margin: 5px 0; text-align: center;"> <span style="font-size: 1.5em;">5</span> <span style="font-size: 1.5em;">0.1</span> °C                 </div> <div style="display: flex; justify-content: space-around; align-items: center;"> <div style="text-align: center;"> </div> <div style="text-align: center;"> <p><b>or</b></p> </div> <div style="text-align: center;"> </div> </div> <p style="text-align: center;">Wait 4 seconds or</p> <div style="text-align: center;"> </div> </div>	<ul style="list-style-type: none"> <li>- Call setpoint resolution <b>S</b> .</li> <li>- The current setting is displayed (here <b>0.1</b> for the works setting of 0.1 °C).</li> <li>- The resolution display <b>0.1</b> flashes.</li> <li>- <b>0.1</b> for 0.1 °C</li> <li>- <b>0.01</b> for 0.01 °C</li> <li>- Display flashes 4 s → new value is automatically accepted, <b>or</b></li> <li>- the value is immediately accepted with the Enter key.</li> </ul>
--	---

### 7.8.2 Defining the type of start mode

Usually it is desirable that the thermostat carries on operating again after an interruption in the voltage supply. However, if for safety reasons you do not wish this, you can insert an intervening manual activation step.

**Master**
**StArT**

3x to **MEnu**

to **PA-rA** 2x

StArT °C

or

Wait 4 seconds or

- Call the start option **StArT** .
- The start mode can be changed here.
- The display **Auto** or **StAn** flashes.
- **Auto**, when operation is to be restored automatically again after an interruption.
- **StAn**, when the standby mode is to be activated after a mains interruption.
- Display flashes 4 s → new value is automatically accepted, **or**
- Value is immediately accepted with the Enter key.
- When the mains voltage is restored after an interruption, standby is activated in the **StAn** mode and **StArT** is displayed. You can quit the standby mode with .

---

**Command**
**Auto start**

Display

Sounds Master

Sounds Command

Language

Master Mode

Autostart

Current consumpt.

Off

On

Pump
Menu
End
T<sub>set</sub>
T<sub>fix</sub>

- Open the device parameter menu via the soft key **Menu** .
- With the cursor keys continue to: → **Settings** → **Basic settings** → **Auto start** .
- **On** is currently active.
- If the standby mode is to be activated after a mains interruption, activate "Off" with or .
- Accept the change with or **End** ,
- or quit the window with without making changes.
- When the mains voltage has been restored after an interruption, you can quit the standby mode with .

62

Starting up

YACE0072 / 19.08.16



### 7.8.3 Defining temperature limits

With this function, it is possible to define a minimum and a maximum temperature in which the thermostat controls. By reaching the temperature limits, a warning appears. In this way setpoint input can be prevented which may damage the heat transfer liquid or the apparatus. For example, if water were used as the heat transfer liquid, +95 °C would be practicable as the maximum temperature and +5 °C as the minimum temperature.

Master	$t_{ih}$ and $t_{il}$						
<p>to MENU to PARA</p>	<ul style="list-style-type: none"> <li>– Call the start option <math>t_{ih}</math> (maximum temperature), or with 4x <math>t_{il}</math> (minimum temperature).</li> </ul>						
	<ul style="list-style-type: none"> <li>– The maximum temperature can be changed here.</li> </ul>						
	<ul style="list-style-type: none"> <li>– The minimum temperature can be changed here.</li> </ul>						
	<ul style="list-style-type: none"> <li>– The maximum temperature (minimum temperature) is displayed flashing.</li> <li>– Set the required limit temperature .</li> <li>– Display flashes 4 s → new value is automatically accepted, <b>or</b></li> <li>– Value is immediately accepted with the Enter key.</li> </ul>						
Command	Limits						
<table border="1"> <tr> <td>Pump</td> <td>Menu</td> <td>End</td> <td>T<sub>set</sub></td> <td>T<sub>fix</sub></td> </tr> </table> <div style="border: 1px solid black; padding: 5px; margin-top: 10px;"> <p>T il (min) -50.0 °C T ih (max) 302.0 °C</p> </div>	Pump	Menu	End	T <sub>set</sub>	T <sub>fix</sub>	<ul style="list-style-type: none"> <li>– Open the device parameter menu via the soft key  Menu .</li> <li>– With the cursor keys continue to <b>Limits</b> .</li> <li>– The minimum and maximum temperatures are displayed.</li> <li>– <b>T il (min)</b> is currently active.</li> <li>– Select the limit to be changed with  or  and confirm with  .</li> </ul>	
Pump	Menu	End	T <sub>set</sub>	T <sub>fix</sub>			

<div style="border: 1px solid black; padding: 10px; margin-bottom: 10px;"> <p>Lower limit (T il)</p> <p style="font-size: 2em; text-align: center;">-50.0</p> <p>Min: -50.0 °C    Max: 301.0 °C</p> </div> <table border="1" style="width: 100%; border-collapse: collapse; text-align: center;"> <tr> <td style="width: 20%;">1</td> <td style="width: 20%;">2</td> <td style="width: 20%;">3</td> <td style="width: 20%;">4</td> <td style="width: 20%;">5</td> </tr> <tr> <td>6</td> <td>7</td> <td>8</td> <td>9</td> <td>0</td> </tr> </table>	1	2	3	4	5	6	7	8	9	0	<ul style="list-style-type: none"> <li>- Enter the desired limit temperature.</li> <li>- Accept the change with  ,</li> <li>- or quit the window with  without making changes.</li> </ul>
1	2	3	4	5							
6	7	8	9	0							

### 7.8.4 Setpoint offset operating mode

With this function it is possible to apply an offset value to the temperature provided by the external temperature probe or a module and then to use it as the setpoint. The bath temperature can, for example, be operated at -25 °C below the temperature of a reactor, which is being measured by the external temperature probe.

<p><b>Master</b></p> <p style="text-align: center; font-size: 1.5em;"><i>SEt.r. .</i></p> <p style="text-align: center;">  3x  to <i>PTENU</i>   to <i>PARA</i>  5x  </p> <div style="border: 1px solid gray; padding: 5px; margin-bottom: 5px; text-align: center;"> <p><i>SEt.r. .</i> °C</p> </div> <div style="border: 1px solid gray; padding: 5px; margin-bottom: 5px; text-align: center;"> <p><i>r OFF</i> °C</p> </div> <p style="text-align: center;">Wait 4 seconds or</p> <p style="text-align: center;"></p> <div style="border: 1px solid gray; padding: 5px; margin-bottom: 5px; text-align: center;"> <p><i>r OFF5</i> °C</p> </div> <p style="text-align: center;">Wait 4 seconds or</p> <p style="text-align: center;"></p>	<ul style="list-style-type: none"> <li>- <i>SEt.r. .</i> in the following submenu, the relative setpoint (Set) and the source of the actual value can be entered.</li> <li>- Continue with .</li> <li>- The offset operating mode is currently deactivated.</li> <li>- To activate it press  and with  change to <i>EP</i> (external Pt100), <i>EA</i> (external via analog module) or <i>ES</i> (external via serial module).</li> <li>- Display flashes 4 s → new value is automatically accepted, <b>or</b></li> <li>- value is immediately accepted with the Enter key.</li> <li>- Continue with . The left-hand window is displayed.</li> <li>- To activate the relative offset input press  and change the value with  or .</li> <li>- Display flashes 4 s → new value is automatically accepted, <b>or</b></li> <li>- value is immediately accepted with the Enter key.</li> </ul>
---	---

Command					<b>Offset source</b> and <b>Setpoint offset</b>
<div style="border: 1px solid black; padding: 5px; display: flex; justify-content: space-between;"> <div style="width: 30%;"> <p>Offset source</p> <p>Setpoint offset</p> </div> <div style="width: 60%; border: 1px solid black; padding: 5px;"> <p><b>Off</b></p> <p>extern Pt100</p> <p>RS232</p> </div> </div>					<ul style="list-style-type: none"> <li>- Open the device parameter menu via the soft key  <b>Menu</b> .</li> <li>- With the cursor keys continue to → <b>Control</b> → <b>Setpoint offset</b> → <b>Offset source</b> .</li> <li>- <b>Off</b> indicates that the setpoint offset is currently deactivated.</li> <li>- Select the setpoint source with  or  and confirm with  .</li> <li>- Interfaces (e.g. RS232) are only displayed if a valid setpoint has already been transmitted.</li> </ul>
Pump	Menu	End	T <sub>set</sub>	T <sub>fix</sub>	
<div style="border: 1px solid black; padding: 5px; display: flex; justify-content: space-between;"> <div style="width: 30%;"> <p>Offset source</p> <p>Setpoint offset</p> </div> <div style="width: 60%; border: 1px solid black; padding: 5px;"> <p><b>0.00 °C</b></p> </div> </div>					<ul style="list-style-type: none"> <li>- With the cursor keys continue to → <b>Setpoint offset</b> .</li> <li>- The standard value is <b>0.00 °C</b> .</li> </ul>
Pump	Menu	End	T <sub>set</sub>	T <sub>fix</sub>	
<div style="border: 1px solid black; padding: 10px; text-align: center;"> <p>Input Setpoint offset:</p> <p style="font-size: 2em; margin: 10px 0;"><b>0.00</b></p> <hr style="width: 20%; margin: 5px auto;"/> <p>Min: -500.00°C Max: 500.00°C</p> </div>					<ul style="list-style-type: none"> <li>- Open the left-hand window with  .</li> <li>- Enter the desired temperature.</li> <li>- Accept the change with  ,</li> <li>- quit the window with  without making changes.</li> </ul>
1	2	3	4	5	
6	7	8	9	0	

### 7.8.5 Restoring works settings





Master	<i>dEF</i>								
<p>3x   to <i>Menu</i> </p> <p>to <i>PARA</i>   3x</p> <div style="border: 1px solid gray; padding: 5px; width: fit-content; margin: 5px auto;"> </div> <p>3 seconds long </p> <p style="text-align: center;">or</p> <p> </p> <p style="text-align: center;"></p>	<p>If you would like to restore all the works settings except the control parameters <i>P id</i> and the probe calibrations <i>CAL</i>,</p> <ul style="list-style-type: none"> <li>- call the works settings <i>dEF</i>.</li> <li>- <i>dEF</i> is displayed.</li> <li>- Press longer than 3 sec.</li> <li>- The changeover is acknowledged with <i>done</i>.</li> <li>- Proceed to the next menu until <i>End</i> appears.</li> <li>- Press this key.</li> </ul>								
Command	Works settings								
<table border="1" style="width: 100%; border-collapse: collapse;"> <tr> <td style="width: 30%; padding: 5px;">All modules</td> <td style="padding: 5px;">all default</td> </tr> <tr> <td style="padding: 5px;">Master</td> <td style="padding: 5px;"><b>only control par. int</b></td> </tr> <tr> <td style="padding: 5px;">Command</td> <td style="padding: 5px;">only control par. ext</td> </tr> <tr> <td style="padding: 5px;">Cool</td> <td style="padding: 5px;">only miscellaneous</td> </tr> </table>	All modules	all default	Master	<b>only control par. int</b>	Command	only control par. ext	Cool	only miscellaneous	<ul style="list-style-type: none"> <li>- Open the device parameter menu via the soft key  <b>Menu</b>.</li> <li>- With the cursor keys continue to → <b>Settings</b> → <b>Works settings</b>.</li> <li>- The window shown opposite appears.</li> <li>- <b>Master</b> and then <b>only control par. int.</b> is shown as a possible choice. There are however various possibilities, which can be selected with  or .</li> <li>- Under <b>All modules</b> Master, Command and all connected modules are reset to the works setting with <b>all default</b>.</li> </ul>
All modules	all default								
Master	<b>only control par. int</b>								
Command	only control par. ext								
Cool	only miscellaneous								
<table border="1" style="width: 100%; border-collapse: collapse;"> <tr> <td style="width: 15%; padding: 5px;">Pump</td> <td style="width: 15%; padding: 5px;">Menu</td> <td style="width: 15%; padding: 5px;">End</td> <td style="width: 15%; padding: 5px;">T<sub>set</sub></td> <td style="width: 15%; padding: 5px;">T<sub>fix</sub></td> </tr> </table>	Pump	Menu	End	T <sub>set</sub>	T <sub>fix</sub>				
Pump	Menu	End	T <sub>set</sub>	T <sub>fix</sub>					

Confirm input!

Enter key: Continue









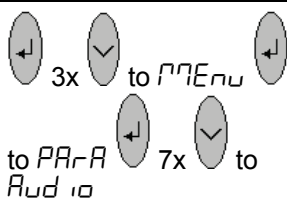
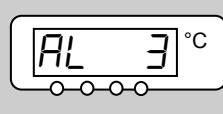

Escape key: Cancel

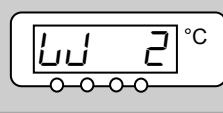
Pump	Menu	End	T <sub>set</sub>	T <sub>fix</sub>
------	------	-----	------------------	------------------

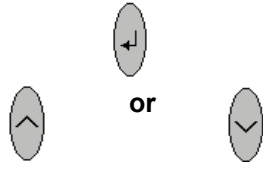
- Under **Master** you have the choice between:
  - **all default**, then all Master settings are reset,
  - **only control para. int.** for the internal control parameters,
  - **only control para. ext.** similar for external,
  - **only miscellaneous** which resets setpoint, pump level, maximum current consumption, control to internal and auto start to "Auto".
- Under **Command** all command settings are reset with **All default**.
- Confirm selection with .
- Confirm the control dialog shown on the left with  or cancel with .
- Return to measurement window with  or .

### 7.8.6 Setting the volume of the acoustic signals

The LAUDA Proline Thermostats signal alarms as a dual-tone acoustic signal and warnings as a continuous tone.

Master	<i>Aud io</i>								
	<ul style="list-style-type: none"> <li>- Call the volume setting <i>Aud io</i> (⇒ 7.6.4).</li> </ul>								
	<ul style="list-style-type: none"> <li>-  takes you to the alarm volume, the currently set volume, here <b>3</b>, is displayed or ...</li> </ul>								
	<ul style="list-style-type: none"> <li>- ...  and 1x  takes you to the warning tone volume.</li> <li>- The currently set volume, here <b>2</b>, is displayed.</li> <li>- The volume display flashes.</li> </ul>								
<p style="text-align: center;">or</p> 	<ul style="list-style-type: none"> <li>- Select volume: <b>0</b> = off to <b>3</b> = loud.</li> </ul>								
<p style="text-align: center;">Wait 4 seconds or</p> 	<ul style="list-style-type: none"> <li>- You hear the alarm or warning tones at the selected volume.</li> <li>- Display flashes 4 s → new value is automatically accepted, <b>or</b></li> <li>- Value is immediately accepted with the Enter key.</li> </ul>								
Command	Sounds								
<table border="1" style="width: 100%; border-collapse: collapse;"> <tr> <td style="width: 50%; padding: 5px;">Alarm</td> <td style="width: 50%; padding: 5px;"> <div style="background-color: black; color: white; padding: 2px;">loud</div>                     medium low off                 </td> </tr> <tr> <td style="padding: 5px;">Pump</td> <td style="padding: 5px;">Menu</td> </tr> <tr> <td style="padding: 5px;">End</td> <td style="padding: 5px;">T<sub>set</sub></td> </tr> <tr> <td style="padding: 5px;">T<sub>set</sub></td> <td style="padding: 5px;">T<sub>fix</sub></td> </tr> </table>	Alarm	<div style="background-color: black; color: white; padding: 2px;">loud</div> medium low off	Pump	Menu	End	T <sub>set</sub>	T <sub>set</sub>	T <sub>fix</sub>	<ul style="list-style-type: none"> <li>- Open the device parameter menu via the soft key  <b>Menu</b> .</li> <li>- With the cursor keys continue to → <b>Settings</b> → <b>Basic Settings</b> → <b>Sounds</b> .</li> <li>- Select either <b>Alarm</b> or <b>Warning</b> .</li> <li>- Example on left: <b>Alarm</b> is set to loud.</li> <li>- Select the desired volume with  or .</li> <li>- Accept selection with  or <b>End</b> or quit the window with  without making changes.</li> </ul>
Alarm	<div style="background-color: black; color: white; padding: 2px;">loud</div> medium low off								
Pump	Menu								
End	T <sub>set</sub>								
T <sub>set</sub>	T <sub>fix</sub>								

### 7.8.7 Entering the offset of the internal temperature probe

If, during checking with a calibrated reference thermometer (e.g. from the LAUDA DigiCal Series) a deviation is found, then the offset (i.e. the additive part of the characteristic) of the internal measuring chain can be adjusted with the following function. The reference thermometer must be dipped into the bath according to the details on the calibration certificate.

<p><b>Master</b></p>		<p><b>CAL 1</b></p> <ul style="list-style-type: none"> <li>- Call the offset adjustment of the internal temperature probe <b>CAL ..</b></li> <li>- <b>CAL 1</b> is displayed.</li> <li>- The actual value of the bath temperature is displayed flashing.</li> <li>- Set the value which you have read from the calibrated reference measurement device (with glass thermometers consider the correction where applicable).</li> <li>- The entered value is accepted and <b>done</b> is displayed.</li> </ul>		
<p><b>Command</b></p>		<p><b>Calibration</b></p> <ul style="list-style-type: none"> <li>- Open the device parameter menu via the soft key <b>Menu</b>.</li> <li>- With the cursor keys continue to <b>Settings</b> → <b>Calibration</b> → <b>intern Pt100</b> → <b>Calibration</b>.</li> <li>- The window shown on the left appears.</li> <li>- Confirm selection with .</li> </ul>		
Pump	Menu	End	T <sub>set</sub>	T <sub>fix</sub>

Temperature value of the ref. temp. measurement device:

20.15

Min: -50.0°C    Max: 302.00

1	2	3	4	5
6	7	8	9	0

- The temperature measurement device shows the true temperature value (with glass thermometers consider the correction where applicable!).
- Change the display in the adjacent window to the true value with cursor or soft keys and accept with or End,
- or quit the window with without making changes.

### 7.8.8 Restoring the works setting of the internal temperature-probe offset

If the offset has been misadjusted unintentionally, the works setting can be restored with this function.

**Master** dEF 1

3x to MENU

2x to CAL . .

1x

dEF 1 °C

3 sec

- Call offset works setting for the internal temperature probe dEF 1.
- dEF 1 is displayed.
- The works setting is accepted after pressing for 3 seconds and done is displayed.

**Command**

intern Pt100  
extern Pt100

**Default**

Calibration  
**Default**

- Open the device parameter menu via the soft key Menu.
- With the cursor keys continue to → Settings → Calibration → intern Pt100 → Default.
- The window shown adjacent appears.
- Confirm selection with .

Pump
Menu
End
T<sub>set</sub>
T<sub>fix</sub>



<div style="border: 1px solid black; padding: 10px; margin-bottom: 10px;"> <p>Confirm input!</p> <p>Enter key: Continue</p> <p>Escape key: Cancel</p> </div> <table border="1" style="width: 100%; border-collapse: collapse;"> <tr> <td style="width: 12.5%;">Pump</td> <td style="width: 12.5%;">Menu</td> <td style="width: 12.5%;">End</td> <td style="width: 12.5%;">T<sub>set</sub></td> <td style="width: 12.5%;">T<sub>fix</sub></td> </tr> </table>	Pump	Menu	End	T <sub>set</sub>	T <sub>fix</sub>	<ul style="list-style-type: none"> <li>- Confirm the control dialog on the right with  or cancel with .</li> <li>- Return to the measurement window with  or .</li> </ul>
Pump	Menu	End	T <sub>set</sub>	T <sub>fix</sub>		



### 7.8.9 Entering the offset of the external temperature probe

If a deviation is found during the check using a calibrated reference thermometer, e.g. from the LAUDA DigiCal Series, then the offset (the additive part of the characteristic) of the external measurement chain can be adjusted with the following function. The reference thermometer must be dipped nearby by the external temperature probe into the consumer bath according to the details on the calibration certificate.

<b>Master</b>	<b>CAL E</b>					
3x to MENU 2x to CAL .. 2x	<ul style="list-style-type: none"> <li>- Call the offset adjustment for the external temperature probe <b>CAL E</b>.</li> <li>- Continue as described in (⇒ 7.8.7) for the internal temperature probe.</li> </ul>					
<b>Command</b>	<b>Calibration</b>					
<table border="1" style="width: 100%; border-collapse: collapse;"> <tr> <td style="width: 50%; padding: 5px;">                 intern Pt100                  extern Pt100             </td> <td style="width: 50%; padding: 5px;"> <div style="border: 1px solid black; padding: 5px;"> <p><b>Calibration</b></p> <p>Default</p> </div> </td> </tr> </table>	intern Pt100 extern Pt100	<div style="border: 1px solid black; padding: 5px;"> <p><b>Calibration</b></p> <p>Default</p> </div>	<ul style="list-style-type: none"> <li>- Open the device parameter menu via the soft key  <b>Menu</b>.</li> <li>- With the cursor keys continue to → <b>Settings</b> → <b>Calibration</b> → <b>extern Pt100</b> → <b>Calibration</b>.</li> <li>- The adjacent window appears.</li> <li>- Confirm selection with .</li> <li>- Continue as described in (⇒ 7.8.7) for the internal temperature probe.</li> </ul>			
intern Pt100 extern Pt100	<div style="border: 1px solid black; padding: 5px;"> <p><b>Calibration</b></p> <p>Default</p> </div>					
<table border="1" style="width: 100%; border-collapse: collapse;"> <tr> <td style="width: 12.5%;">Pump</td> <td style="width: 12.5%;">Menu</td> <td style="width: 12.5%;">End</td> <td style="width: 12.5%;">T<sub>set</sub></td> <td style="width: 12.5%;">T<sub>fix</sub></td> </tr> </table>	Pump	Menu	End	T <sub>set</sub>	T <sub>fix</sub>	
Pump	Menu	End	T <sub>set</sub>	T <sub>fix</sub>		

### 7.8.10 Restoring the works setting of the external temperature-probe offset

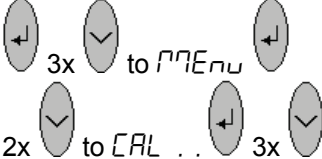
If the offset has been misadjusted unintentionally, the works setting can be restored with this function.

<b>Master</b>		<b>dEF E</b>				
	to <b>PT100</b>	<ul style="list-style-type: none"> <li>- Call the offset works setting for the external temperature probe <b>dEF E</b>.</li> <li>- Continue as described in (⇒ 7.8.8) for the internal temperature probe.</li> </ul>				
<b>Command</b>		<b>Default</b>				
<table border="1"> <tr> <td>intern Pt100</td> <td>Calibration</td> </tr> <tr> <td>extern Pt100</td> <td><b>Default</b></td> </tr> </table>		intern Pt100	Calibration	extern Pt100	<b>Default</b>	<ul style="list-style-type: none"> <li>- Open the device parameter menu via the soft key  <b>Menu</b>.</li> <li>- With the cursor keys continue to → <b>Settings</b> → <b>Calibration</b> → <b>extern Pt100</b> → <b>Default</b>.</li> <li>- The adjacent window appears.</li> <li>- Confirm selection with .</li> <li>- Continue as described in (⇒ 7.8.8) for the internal temperature probe.</li> </ul>
intern Pt100	Calibration					
extern Pt100	<b>Default</b>					
Pump	Menu	End				
		T <sub>set</sub>				
		T <sub>fix</sub>				

**7.9 Graphical display of temperature measurements (Command)**

<b>Command</b>					Screen and Graph		
<div style="display: flex; justify-content: space-around; font-weight: bold;"> <span>T<sub>set</sub>25.00</span> <span>T<sub>int</sub>25.01</span> <span>T<sub>ext</sub>25.02</span> </div>							
					<ul style="list-style-type: none"> <li>- Press the soft key  <b>Screen</b> a number of times as required until the graph recorder window appears.</li> <li>- With the soft key  <b>Graph</b> you enter the menu for the configuration of the graph recorder.</li> <li>- <b>Mode</b> defines,</li> <li>- whether the recording is to run continuously as <b>Online graph</b>,</li> <li>- or whether it is to be started with <b>Start record</b> and later terminated with <b>Stop record</b>. When this start/stop mode is active, <b>Rec</b> flashes at the top left of the display.</li> </ul>		
Pump	Menu	Screen	T <sub>set</sub>	Graph			
<table border="1" style="width: 100%; border-collapse: collapse;"> <tr> <td style="width: 50%; padding: 5px;"> <b>Mode</b>                  Displayed value                  Legend                  Sample Time                  Time axis                  Time base                  Temp. scale                  Temp. limits             </td> <td style="width: 50%; padding: 5px; text-align: center;"> <div style="background-color: black; color: white; padding: 2px; margin-bottom: 5px;"><b>Online graph</b></div>                 Start Record             </td> </tr> </table>					<b>Mode</b> Displayed value Legend Sample Time Time axis Time base Temp. scale Temp. limits	<div style="background-color: black; color: white; padding: 2px; margin-bottom: 5px;"><b>Online graph</b></div> Start Record	<ul style="list-style-type: none"> <li>- <b>Displayed value</b> defines,</li> <li>- which of the measurements <b>T<sub>int</sub></b>, <b>T<sub>set</sub></b> and/or <b>T<sub>ext</sub></b> is to be graphically displayed. In the menu all combinations are offered.</li> <li>- <b>Legend</b> defines,</li> <li>- whether the axis label is to be <b>invisible</b> or <b>visible</b>.</li> </ul>
<b>Mode</b> Displayed value Legend Sample Time Time axis Time base Temp. scale Temp. limits	<div style="background-color: black; color: white; padding: 2px; margin-bottom: 5px;"><b>Online graph</b></div> Start Record						
Pump	Menu	End	T <sub>set</sub>	T <sub>fix</sub>			
<table border="1" style="width: 100%; border-collapse: collapse;"> <tr> <td style="width: 50%; padding: 5px;"> <b>Mode</b>                  Displayed value                  Legend                  Sample time                  Time axis                  Time base                  Temp. scale                  Temp. limits             </td> <td style="width: 50%; padding: 5px; text-align: center;"> <div style="background-color: black; color: white; padding: 2px; margin-bottom: 5px;"><b>Tset Tint Text</b></div>                 Tset Tint                  Tset Text                  Tint Text                  Tint                  Text                  Tset             </td> </tr> </table>					<b>Mode</b> Displayed value Legend Sample time Time axis Time base Temp. scale Temp. limits	<div style="background-color: black; color: white; padding: 2px; margin-bottom: 5px;"><b>Tset Tint Text</b></div> Tset Tint Tset Text Tint Text Tint Text Tset	<ul style="list-style-type: none"> <li>- <b>Sample time</b> defines with which time interval the measurements are recorded. 5 possibilities are offered:</li> <li>- From <b>2s (max. 1h45min)</b> up to <b>2min (max. 105h)</b>.</li> <li>- <b>Time axis</b> defines over which time range the measurements are to be displayed.</li> <li>- With <b>Automatic</b> the program finds the optimum display.</li> <li>- From <b>9min</b> up to <b>144h</b>.</li> <li>- <b>Time base</b> defines whether scaling is to be carried out.</li> <li>- With <b>Relative</b> the start occurs at 00:00:00.</li> <li>- With <b>Absolute</b> the current time is displayed.</li> </ul>
<b>Mode</b> Displayed value Legend Sample time Time axis Time base Temp. scale Temp. limits	<div style="background-color: black; color: white; padding: 2px; margin-bottom: 5px;"><b>Tset Tint Text</b></div> Tset Tint Tset Text Tint Text Tint Text Tset						
Pump	Menu	End	T <sub>set</sub>	T <sub>fix</sub>			

<p>Mode Displayed value Legend Sample Time Time axis Time base Temp. scale <b>Temp. limits</b></p>	<p><b>Temp. min 22.00</b> Temp. max 27.00</p>	<p><b>Temp. scale</b> defines how the scaling is to be carried out:</p> <ul style="list-style-type: none"> <li>– <b>automatic</b>, by the program, <b>or</b></li> <li>– <b>manual</b> in that you yourself define the limits with the next menu point.</li> </ul> <p>The min. and max. values for the graphical display are manually entered with <b>Temp. limits</b>.</p> <ul style="list-style-type: none"> <li>– <b>Temp. min 22.00°C</b> is the momentary minimum value.</li> <li>– <b>Temp. max 27.00°C</b> is the momentary maximum value.</li> <li>– The highlighted value can in each case be changed with . Enter the desired new value in the changes window in the usual way.</li> <li>– When setting the minimum value, the largest permissible value (here 26.90 °C, since the maximum value is 27 °C) is stated.</li> <li>– When setting the maximum value, it is conversely the minimum value, which is entered.</li> <li>– However, if a value is entered which exceeds the other corresponding limit, then this warning is issued: <b>Warning: Value not in input range</b>.</li> </ul>										
<table border="1" style="width: 100%; border-collapse: collapse;"> <tr> <td>Pump</td> <td>Menu</td> <td>End</td> <td>T<sub>set</sub></td> <td>T<sub>fix</sub></td> </tr> </table>	Pump		Menu	End	T <sub>set</sub>	T <sub>fix</sub>						
Pump	Menu	End	T <sub>set</sub>	T <sub>fix</sub>								
<p>y-axis Limit:</p> <div style="border: 2px solid black; padding: 10px; margin: 10px auto; width: 80%;"> <p style="font-size: 2em; text-align: center;"><b>22.00</b></p> <p style="text-align: center;">Min: -150.00°C    Max: 26.90 °C</p> </div>												
<table border="1" style="width: 100%; border-collapse: collapse;"> <tr> <td>1</td> <td>2</td> <td>3</td> <td>4</td> <td>5</td> </tr> <tr> <td>6</td> <td>7</td> <td>8</td> <td>9</td> <td>0</td> </tr> </table>		1	2	3	4	5	6	7	8	9	0	
1	2	3	4	5								
6	7	8	9	0								

### 7.10 Programmer (PGM only Command)

Almost any temperature/time profile can be created with the programmer. A desired bath temperature can be approached as quickly as possible or via a defined ramp. Furthermore, the pump level and the behavior of the switching outputs can be defined. Five temperature/time programs are provided for free programming. Each program consists of a number of temperature/time segments. Also included are details of how often the program is to be executed (loops). The sum of all segments of all programs may be up to a maximum of 150. Typical segments are:

**Ramp:** If a time is specified, then the segment is a ramp, which is described by the target temperature, i.e. the temperature at the end of the segment, and the duration from the start to the end of the segment.

**Step:** Without any specified time the final temperature is approached as quickly as possible.

**Temperature hold phase:** No temperature change (i.e. the temperatures at the start and end of a segment are the same).



The programmer can be controlled or changed via the RS232 interface, the timer or switching contacts.

#### 7.10.1 Program example

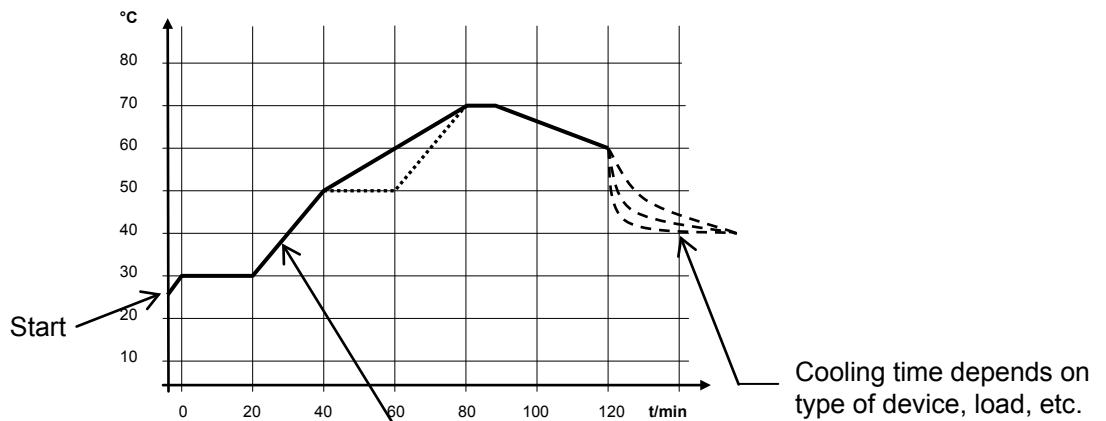

Real program example with 6 segments

No	T end °C	Time [h:m]	Tolerance
Start	30.00°C	-----	0.00°C
1	30.00°C	00:20	0.10°C
2	50.00°C	00:20	0.00°C
3	70.00°C	00:40	0.00°C
4	70.00°C	00:10	0.10°C
5	60.00°C	00:30	0.00°C
6	30.00°C	00:00	0.00°C
Pump	Menu	End	Delete

No	Pump	Out 1	Out 2	Out 3
Start	-----	-----	-----	-----
1	2	-----	-----	-----
2	3	-----	-----	-----
3	4	-----	-----	-----
4	2	-----	-----	-----
5	2	-----	-----	-----
6	2	-----	-----	-----
Pump	Menu	End	Delete	



Each program begins with the segment "Start". It defines at which temperature Segment 1 is to continue the program. It is not possible to specify a time for the Start segment. For thermostats without cooling ability, the start temperature must be selected higher than the bath temperature, which prevails before the program start. Without the Start segment, Segment 1 would be different depending on the bath temperature at the start of the program.

**Edited program example (see dashed curve in the graph on previous page).**

No	T end °C	Time [h:m]	Tolerance
Start	30.00°C	-----	0.00°C
1	30.00°C	00:20	0.10°C
2	50.00°C	00:20	<b>0.00°C</b> ③
<b>3</b> ①	<b>50.00°C</b> ①	<b>00:20</b> ②	<b>0.10°C</b> ③
4	70.00°C	<b>00:20</b> ②	0.00°C
5	70.00°C	00:10	<b>0.80°C</b> ③
6	60.00°C	00:30	0.00°C
7	30.00°C	00:00	0.00°C
Pump	Menu	End	Insert Delete

No	Pump	Out 1	Out 2	Out 3
Start	-----	-----	-----	-----
1	2	-----	-----	-----
2	2	-----	-----	-----
<b>3</b>	<b>2</b>	-----	-----	-----
4	2	-----	-----	-----
5	2	-----	-----	-----
6	2	-----	-----	-----
7	2	-----	-----	-----
Pump	Menu	End	Insert	Delete

① Insert new segment (⇒ Section 7.10.4)

② ③ Change segment time or tolerance (⇒ Section 7.10.4)



**The field tolerance** (refer to the above program table and the graph below):

- It facilitates exact conformance to the dwell time at a specified temperature. Segment 1 is not processed until the bath temperature is within the tolerance range ①, so that the ramp (Segment 2) starts delayed at ②.
- A tolerance range which is too tight can however also cause undesired delays. **In particular with external control** the range should not be chosen too tightly. In Segment 5 a larger tolerance has been entered, so that the desired time of ten minutes is maintained even with settling action ③.
- Only flat (slow) ramps should be programmed where necessary with a tolerance range. Steep ramps which lie close to the maximum possible heating or cooling rates of the thermostat may be severely delayed by a tolerance range that is too tight (here in Segment 2) ④.

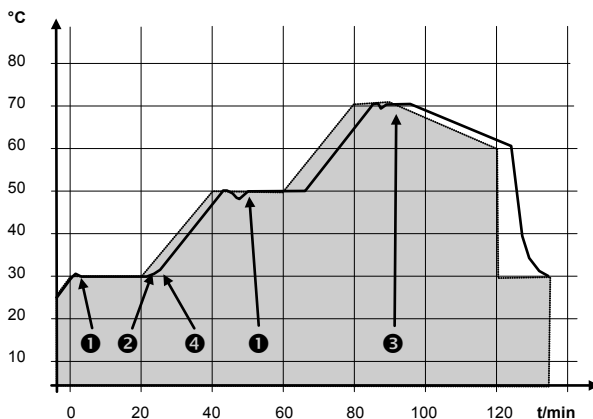





Example for the influence of the tolerance field input in case of external bath temperature control:

The setpoint temperature of the programmer is shown in grey.







The actual temperature in the external bath container is represented as a continuous line.

**7.10.2 Selecting and starting the program (Start, Hold, Stop)**

Here you will learn how to select and start a program that has already been created. If no program has been created see (⇒ 7.10.4) Creating or modifying a program (Edit).

<b>Command</b>		<b>Programmer</b> <b>Program 1</b>					
Pump Settings Graph Clock Programmer Interfaces Control Limits	<div style="border: 1px solid black; padding: 5px;"> <b>Program 1</b>                      Program 2                      Program 3                      Program 4                      Program 5                      Ramp function                 </div>	<ul style="list-style-type: none"> <li>- Open the device parameter menu via the soft key  <b>Menu</b> .</li> <li>- With the cursor keys continue to: → <b>Programmer</b> → <b>Program 1</b> .</li> <li>- Confirm with the key .</li> </ul>					
<table border="1" style="width: 100%; border-collapse: collapse;"> <tr> <td style="width: 20%;">Pump</td> <td style="width: 20%;">Menu</td> <td style="width: 20%;">End</td> <td style="width: 20%;">T<sub>set</sub></td> <td style="width: 20%;">T<sub>fix</sub></td> </tr> </table>	Pump	Menu	End	T <sub>set</sub>	T <sub>fix</sub>		
Pump	Menu	End	T <sub>set</sub>	T <sub>fix</sub>			
Status Edit Loops Graph Info	<div style="border: 1px solid black; padding: 5px;"> <b>Start</b> </div>	<ul style="list-style-type: none"> <li>- The submenu <b>Status</b> appears.</li> <li>- Using the <b>Status</b> menu, the selected program can be:                         <ol style="list-style-type: none"> <li>1. started <b>Start</b> ,</li> <li>2. paused <b>Hold</b> ,</li> <li>3. continued <b>Continue</b> or</li> <li>4. terminated <b>Stop</b> .</li> </ol> </li> </ul>					
<table border="1" style="width: 100%; border-collapse: collapse;"> <tr> <td style="width: 20%;">Pump</td> <td style="width: 20%;">Menu</td> <td style="width: 20%;">End</td> <td style="width: 20%;">T<sub>set</sub></td> <td style="width: 20%;">T<sub>fix</sub></td> </tr> </table>	Pump	Menu	End	T <sub>set</sub>	T <sub>fix</sub>		In addition, the standby key  stops the programmer! (Pause operation). After standby is deactivated, the programmer goes on! Commands, which, depending on the situation, cannot be executed, are not displayed. <b>Continue</b> therefore only appears when <b>Hold</b> has been activated.
Pump	Menu	End	T <sub>set</sub>	T <sub>fix</sub>			
Status Edit Loops Graph Info	<div style="border: 1px solid black; padding: 5px;"> <b>Hold</b>                      Stop                 </div>	<ul style="list-style-type: none"> <li>- Once the start has been confirmed with , <b>Prog. 1 running</b> appears at the bottom.</li> </ul>					
<table border="1" style="width: 100%; border-collapse: collapse;"> <tr> <td style="width: 20%;">Pump</td> <td style="width: 20%;">Menu</td> <td style="width: 20%;">End</td> <td style="width: 20%;"><b>Prog.1 running</b></td> <td style="width: 20%;"></td> </tr> </table>	Pump	Menu	End	<b>Prog.1 running</b>			
Pump	Menu	End	<b>Prog.1 running</b>				

### 7.10.3 Interrupting, continuing or terminating the program (Hold, Continue, Stop)

Command				Programmer	Program 1	Status
<div style="border: 1px solid black; padding: 5px;">           Status            Edit            Loops            Graph            Info         </div>	<div style="border: 1px solid black; padding: 5px;"> <b>Hold</b>            Stop         </div>			<ul style="list-style-type: none"> <li>- After a program has been started by pressing the  key, the command options <b>Hold</b> or <b>Stop</b> are shown.</li> <li>- Here, with the aid of the keys  or  and  the running program can be paused with <b>Hold</b> or terminated with <b>Stop</b>.</li> <li>- Once the program has been terminated, the device runs with the last setpoint setting.</li> </ul>		
Pump	Menu	End	<b>Prog.1running</b>			
<div style="border: 1px solid black; padding: 5px;">           Status            Edit            Loops            Graph            Info         </div>	<div style="border: 1px solid black; padding: 5px;"> <b>Continue</b>            Stop         </div>			<ul style="list-style-type: none"> <li>- Continuation of a program paused with <b>Hold</b> occurs using <b>Continue</b> which is obtained with .</li> </ul>		
Pump	Menu	End	<b>Prog.1Standby</b>			
<div style="border: 1px solid black; padding: 5px;">           Status            Edit            Loops            Graph            Info         </div>	<div style="border: 1px solid black; padding: 5px;"> <b>Continue</b>            Stop         </div>			<ul style="list-style-type: none"> <li>- In addition, the standby key  stops the programmer. The pump, heater and cooling unit are switched off. Follow the safety information (⇒ 7.7.3).</li> <li>- After pressing the standby key  again, the programmer returns to the previously selected operating mode: Pause or active operation depending on what was previously selected.</li> </ul>		
Pump	Menu	End	<b>Pr. 1 Standby</b>			



### 7.10.4 Creating or modifying a program (Edit)

Here, there are the following functions:

- Entry of a program.
- Display of the program data of a saved program and modification of the segment data.
- Insertion or appending of a new segment.
- Deletion of a segment.



- In addition, when a program has just been executed, new segments can be inserted and existing ones modified, even the currently active segment. Furthermore, all segments, except the currently active one, can be deleted at any time.
- Modifications to the currently running segment are possible. The segment then continues as though the modification had been applicable since the start of the segment.

**However:** If the new segment time is shorter than the segment time that has already run, then the program skips to the next segment.

- If a segment time >999 h: 59 min is required, then this time period must be shared over a number of consecutive segments.

**Entering a program:**

Program example (⇒ 7.10.1)

<b>Command</b>					<b>Programmer</b> <b>Program1</b> <b>Edit</b> <b>Modify</b>
Status <input type="text" value="Edit"/> Loops Graph Info	<div style="border: 2px solid black; padding: 5px; display: inline-block;">                     Modify                      Delete                 </div>				<ul style="list-style-type: none"> <li>- In the <b>Edit</b> menu one can <b>Modify</b> or <b>Delete</b> a program.</li> <li>- Press the  key.</li> <li>- Continue to <b>Modify</b> with the key .</li> <li>- There is the possibility of modifying single segments, i.e. segments can be entered as new, changed and also deleted.</li> </ul>
Pump	Menu	End	T <sub>set</sub>	T <sub>fix</sub>	
No.	T end °C	Time [h:m]	Tolerance		
Start	30.00°C	-----	3.00°C		
1	30.00°C	00:30	3.00°C		
Pump	Menu	End	Insert	Delete	

- In the "Start" line enter in the field "T end °C" the temperature at which the sequence is to start (default value is 30 °C). A time entry is not possible in the "Start" segment, because the thermostat immediately executes Segment 1 on reaching the start temperature.
- Delete single segments (rows) with **Delete**.
- For thermostats without cooling ability, the setpoint temperature must be obtainable, i.e. above the bath temperature displayed at the time of the program start.



End of segment temperature:

# 25.00

Min: -150.00°C Max:450.00°C

1	2	3	4	5
6	7	8	9	0

Input segment time:

# 003:00

Hours(max.999):Minutes











1	2	3	4	5
6	7	8	9	0

Temp. tolerance (0=off):

# 10.00











Min: 0.00°C Max:450.00°C

6	7	8	9	0

- A new segment is produced by moving the cell with the black background to a blank line with the cursor keys and then pressing the soft key  **Insert**. The values of the cell located above it are automatically copied.
- If the field in the column **T end °C** has a black background, the entry mode "End of segment temperature" is obtained by pressing the  key. Depending on the setting, that is the temperature, which the thermostat is to achieve on the internal or external temperature probe.
- Enter the value, confirm with the  key and continue to the "Time" entry field with .
- If the field in the column **Time** has a black background, the entry mode for the "Segment time" time setting is obtained by pressing the  key.
- If 0 is entered into the field "Time", ----- appears. Then the final temperature is approached as quickly as possible. With a time entry the final temperature is obtained exactly after the time expires (ramp).
- Enter the segment time and confirm with the  key.
- Continue to the "Tolerance" entry field with .
- If the field in the column "Tolerance" has a black background, the entry mode for the "Temperature tolerance" is obtained by pressing the  key. It defines how accurately the end of segment temperature is to be obtained before the next segment is processed. A tolerance which is selected too small can stop the next segment from being started according to plan.
- Set the temperature tolerance and confirm with .
- Continue with  to the entry field "Pump".

Pump level	Level 8	Level 7	Level 6	<b>Level 5</b>	Level 4	Level 3	Level 2	Level 1	-----
Pump	Menu	End	T <sub>set</sub>	T <sub>fix</sub>					

Contact out	-----	open	closed	
Pump	Menu	End	T <sub>set</sub>	T <sub>fix</sub>

- If the field in the column "Pump" has a black background, the entry mode for the **Pump level** is obtained by pressing the key .
- With  or  select Pump Level 1 – 8 or ----- and confirm with . ----- stands for "no change to previous segment", i.e. when "-----" is present in all fields, the pump level always retains the start setting or the setting before the program start.
- Continue with  to the field "Out 1", "Out 2" or "Out 3".
- The contact outputs of the contact module (if present, special accessory) are programmed here.
- If the field in the column "Out 1" has a black background, the entry mode for the **Contact output** is obtained by pressing the  key.
- With  or  select -----, **Open** or **Closed** and confirm with . ----- stands for no change with respect to the previous segment, i.e. if ----- is present in all fields, the contact setting of the start setting or that from the program start is retained.
- If applicable, continue with  to "Out 2" and "Out 3".
- Programming is terminated with  or **End**.

**7.10.5 Defining the number of program loops (Loops)**

<b>Command</b>					<b>Programmer</b>   <b>Program1</b>   <b>Loops</b>										
Status Edit Loops Graph Info	<div style="border: 1px solid black; padding: 5px; width: fit-content; margin: 0 auto;">1</div>				<ul style="list-style-type: none"> <li>- If required, programs can be looped many times.</li> <li>- With  and  access the menu <b>Loops</b> .</li> <li>- Select the number of desired program loops.</li> </ul>										
Pump   Menu   End   T <sub>set</sub>   T <sub>fix</sub>	<div style="border: 1px solid black; padding: 10px; width: fit-content; margin: 0 auto;">                     Loops (0=infinite)   <div style="font-size: 2em; text-align: center; margin: 10px 0;">1</div> <hr style="width: 50%; margin: 0 auto;"/>                     Min: 0                      Max:255                 </div>														
<table border="1" style="margin: 0 auto; border-collapse: collapse;"> <tr> <td style="width: 20px; text-align: center;">1</td> <td style="width: 20px; text-align: center;">2</td> <td style="width: 20px; text-align: center;">3</td> <td style="width: 20px; text-align: center;">4</td> <td style="width: 20px; text-align: center;">5</td> </tr> <tr> <td style="text-align: center;">6</td> <td style="text-align: center;">7</td> <td style="text-align: center;">8</td> <td style="text-align: center;">9</td> <td style="text-align: center;">0</td> </tr> </table>					1	2	3	4	5	6	7	8	9	0	<ul style="list-style-type: none"> <li>- Press the  key, set the required number. Entering 0 causes the program to repeat continuously.</li> <li>- Confirm the entry with the  key and return to the display.</li> <li>- You can quit the Edit mode with  or <b>End</b> .</li> </ul>
1	2	3	4	5											
6	7	8	9	0											

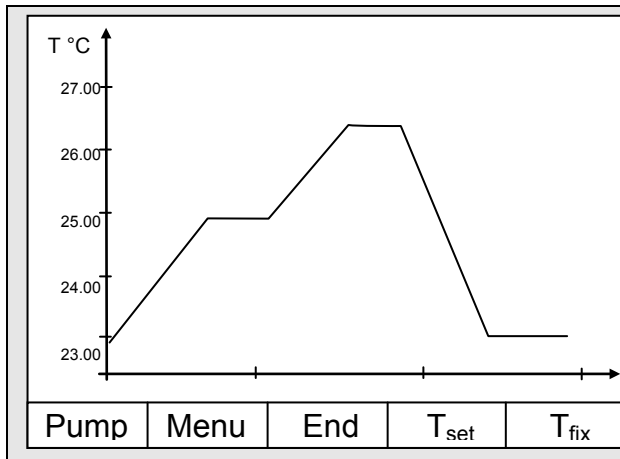

**7.10.6 Viewing the program sequence as a graph (Graph)**

<b>Command</b>					<b>Programmer</b>   <b>Program1</b>   <b>Graph</b>
Status Edit Loops Graph Info	<div style="border: 1px solid black; padding: 5px; width: fit-content; margin: 0 auto;">Show chart</div>				<ul style="list-style-type: none"> <li>-  takes you to the submenu <b>Graph</b> .</li> <li>- Press the  key → <b>Show chart</b> and </li> <li>- The program sequence is shown.</li> </ul>
Pump   Menu   End   T <sub>set</sub>   T <sub>fix</sub>					



- The display of the programmed temperature curve can be quit with  or **End**.

### 7.10.7 Obtaining information on a program (Info)

Command	Programmer	Program1	Info	
<div style="border: 1px solid black; padding: 5px;"> <p>Status</p> <p>Edit</p> <p>Loops</p> <p>Graph</p> <p style="border: 1px solid black; display: inline-block; padding: 2px;">Info</p> </div>	<div style="border: 1px solid black; padding: 5px;"> <p><b>Segments 2</b></p> <p>Temp.min 20.00°C</p> <p>Temp.max 40.00°C</p> <p>Duration 01:00</p> <p>Seg. free 145</p> <p>Actual Seg. 5</p> <p>Seg. Remain 00:05</p> <p>Loop actual 3</p> </div>			<ul style="list-style-type: none"> <li>- Continue with  to <b>Info</b>.</li> <li>- Here, all information is displayed about the entered program sequence.</li> <li>- Number of segments.</li> <li>- Minimum temperature in °C.</li> <li>- Maximum temperature in °C.</li> <li>- Program duration in hh: mm (without the time, which is necessary to process step changes in temperature).</li> <li>- Number of free segments.</li> <li>- Segment, which is at present (currently) being processed.</li> <li>- Residual time of the current segment in hours and minutes.</li> <li>- Current pass; in the example the third of all passes is running.</li> </ul> <p>The last three points are only displayed when a program runs.</p>
<div style="border: 1px solid black; display: inline-block; padding: 2px;"> <span>Pump</span> <span>Menu</span> <span>End</span> <span style="background-color: black; color: white; padding: 2px;">Prog.1 Standby</span> </div>	<ul style="list-style-type: none"> <li>- Quit the window with  or <b>End</b>.</li> </ul>			

**7.11 Ramp function**

With the ramp function, temperature changes over any time period can be conveniently entered. This is especially advantageous with very low temperature changes (e.g. 0.1 °C/ day).

Example: From the current outflow temperature (e.g. 242.4 °C), 200 °C of cooling is to occur over 5 days. Then the temperature change is entered as 200 °C and the time as 5 days.



The ramp function is executed until it is manually terminated or until the temperature limits  $T_{il}$  (min) or  $T_{ih}$  (max) described in Section 7.8.3 are attained.

Command					<b>Programmer</b> <b>Ramp function</b>					
Pump Settings Graph Clock Programmer Interfaces Control Limits	Program 1 Program 2 Program 3 Program 4 Program 5 Ramp function	– Open the list of device parameters using the soft key <b>Menu</b> .			– With the cursor keys continue to → <b>Programmer</b> → <b>Ramp function</b> .					
<table border="1" style="width: 100%; border-collapse: collapse;"> <tr> <td style="width: 15%; text-align: center;">Pump</td> <td style="width: 15%; text-align: center;">Menu</td> <td style="width: 15%; text-align: center;">End</td> <td style="width: 15%; text-align: center;"><math>T_{set}</math></td> <td style="width: 15%; text-align: center;"><math>T_{fix}</math></td> </tr> </table>					Pump	Menu	End	$T_{set}$	$T_{fix}$	– Confirm with the key .
Pump	Menu	End	$T_{set}$	$T_{fix}$						
Status Temp. change Time Time unit	Second(s) Minute(s) Hour(s) Day(s)	– Enter a positive or negative temperature value with <b>Temp. change</b> .			– With <b>Time</b> enter a figure (without time unit).					
<table border="1" style="width: 100%; border-collapse: collapse;"> <tr> <td style="width: 15%; text-align: center;">Pump</td> <td style="width: 15%; text-align: center;">Menu</td> <td style="width: 15%; text-align: center;">End</td> <td style="width: 15%; text-align: center;"><math>T_{set}</math></td> <td style="width: 15%; text-align: center;"><math>T_{fix}</math></td> </tr> </table>					Pump	Menu	End	$T_{set}$	$T_{fix}$	– With <b>Time unit</b> choose between <b>Second(s)</b> up to <b>Day(s)</b> .
Pump	Menu	End	$T_{set}$	$T_{fix}$						
– Under <b>Status</b> the ramp is started → <b>Start</b> or stopped → <b>Stop</b> .					– When the ramp function is being executed, <b>Ramp active</b> appears in the window bar.					
– Without manual switch-off the ramp terminates at the latest at $T_{il}$ (min) or $T_{ih}$ (max).										

### 7.12 Timer function (Command)

Using the timer function, the thermostat can carry out an action at a certain time or after a certain waiting period. The actions are: switching on the thermostat, entering the standby mode or one of the 5 programs in the programmer.



Command		Clock	Timer 1	Timer 2					
Pump Settings Graph Clock Programmer Interfaces Control Limits	Set time Set date Timer 1 Timer 2 Format of date	<ul style="list-style-type: none"> <li>- Open the device parameter menu via the soft key  Menu .</li> <li>- With the cursor keys continue to: → Clock → Timer 1 ,</li> <li>- or to Timer 2 ,</li> <li>- with the menu Status the selected timer is switched off or on .</li> <li>- The standby key does not stop the timer!</li> </ul>							
<table border="1" style="width: 100%; border-collapse: collapse;"> <tr> <td style="width: 20%;">Pump</td> <td style="width: 20%;">Menu</td> <td style="width: 20%;">End</td> <td style="width: 20%;">T<sub>set</sub></td> <td style="width: 20%;">T<sub>fix</sub></td> </tr> </table>	Pump	Menu	End	T <sub>set</sub>	T <sub>fix</sub>				
Pump	Menu	End	T <sub>set</sub>	T <sub>fix</sub>					
<div style="display: flex; align-items: center;"> <p>Please exercise caution when thermostat is in standby mode. A previously activated timer mode could unintentionally start the thermostat again from the standby mode.</p> </div>									
Status Function Action Set Time Set Date	Weekplan Time absolute Time relative	<p>The menu Function is used to define when an action is executed:</p> <ul style="list-style-type: none"> <li>- Similar to an electronic mains timer, Weekplan enables two switching events to be carried out each day. The cycle is repeated after 7 days.</li> <li>- Time absolute defines a time and a date on which a once-only action (switching event) occurs. The time point is set with Set time and with Set date .</li> <li>- Time relative defines a waiting period after which a once-only action occurs. With Set time up to 99h: 59min can be entered. ("Set date" is masked out with this function selection.)</li> <li>- If the Weekplan is activated, in this window only Status, Function and Weekplan are displayed.</li> </ul>							
<table border="1" style="width: 100%; border-collapse: collapse;"> <tr> <td style="width: 20%;">Pump</td> <td style="width: 20%;">Menu</td> <td style="width: 20%;">End</td> <td style="width: 20%;">T<sub>set</sub></td> <td style="width: 20%;">T<sub>fix</sub></td> </tr> </table>	Pump	Menu	End	T <sub>set</sub>	T <sub>fix</sub>				
Pump	Menu	End	T <sub>set</sub>	T <sub>fix</sub>					





Weekplan				
	Time	Action	Time	Action
Monday	07:30	Start	17:00	-----
Tuesday	10:00	Prog.4	17:00	-----
Wednesday	08:00	-----	17:00	-----
Thursday	08:00	-----	17:00	-----
Friday	08:00	-----	16:00	Standby
Saturday	08:00	-----	17:00	-----
Sunday	08:00	-----	17:00	-----

Pump	Menu	End	T <sub>set</sub>	T <sub>fix</sub>
------	------	-----	------------------	------------------

- **Weekplan** → **Arrange** takes you to the window shown on the left.
- Using the cursor keys ,  select the field, which is to be filled in.
- Open the input dialog of the field with : Select a time in the time fields and an action in the action field.
- In the example on the right, the thermostat is started on Monday at 7:30h, Program 4 is executed at 10:00h on Tuesday and the standby mode is switched in on Friday at 16:00h. Fields displaying ----- are passive.

Confirm each field selection with  or quit with  without making changes.

The menu **Action** is used to define **what** is to be carried out:

- **Start** activates the thermostat from the standby mode.
- **Standby** activates the standby mode (refrigerating unit, heater and pump are switched off).
- **Program X** all actions of this program defined in the programmer are processed.

Status	<table border="1"> <tr><td>Start</td></tr> <tr><td>Standby</td></tr> <tr><td>Program 1</td></tr> <tr><td>Program 2</td></tr> <tr><td>Program 3</td></tr> <tr><td>Program 4</td></tr> <tr><td>Program 5</td></tr> </table>	Start	Standby	Program 1	Program 2	Program 3	Program 4	Program 5
Start								
Standby								
Program 1								
Program 2								
Program 3								
Program 4								
Program 5								
Function								
Action								
Set time								
Set date								

Pump	Menu	End	T <sub>set</sub>	T <sub>fix</sub>
------	------	-----	------------------	------------------

### 7.13 Control parameters

The control parameters are optimized ex-works for operation as a bath thermostat (with water as the heat transfer liquid) with internal control. The parameters are also preset for the operation of external containers with external control. Sometimes however, the operation of external containers requires adaptation. In addition, the thermal capacity and viscosity of the heat transfer liquid sometimes require adaptation.



- The intelligent menu guidance with the Master and Command detects whether you have set the device (as described in Section 7.7.4), to internal or external control and only displays the relevant dialog boxes in each case.
- Your Proline Thermostat automatically optimizes some control parameters. This automatic mechanism should only be deactivated and manually optimized in exceptional cases.

### 7.13.1 Internal control variable (integral measurement probe)

Only read further here if you have no external temperature probe connected (and activated according to Section 7.7.4 as control variable).

**Master**

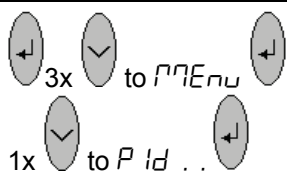

**P** 8.0 °C

**t<sub>ud</sub> A** °C

**P Id ..**

- As shown in the menu structure (⇒ 7.6.5), the parameters for the internal control variable can be set.
- Select the parameter with or and confirm with . The set value is displayed. Adapt it with or and confirm with .
- Example: Proportional range is 8.0 K.
- Proportional range:  $t_P = Xp$  in Kelvin.
- Reset time  $t_n = Tn$  in seconds.
- Derivative time (Auto/ Man)  $t_u = Tv$  in seconds. The thermostat logic system only permits values with  $Tn > Tv!$
- Damping time (Auto/ Man)  $t_d = Td$  in seconds.
- $Tv, Td$  changeover to auto/ man  $t_{ud} A = \text{Auto or } \uparrow = \text{Man}$ . The works setting is Automatic. Only experienced control technicians should change these two parameters!

---

**Command**

Control Parameters

Control para. sets	<b>Xp</b>	<b>6,0</b>
Tv manual/auto	Tn	30
	Tv (auto)	21
	Td (auto)	3,5

Pump
Menu
End
T<sub>set</sub>
T<sub>fix</sub>

**Control**
**Control Parameters**
**Control Parameters**

- Open the device parameter menu via the soft key **Menu**.
- With the cursor keys continue to **→ Control → Control Parameters → Control Parameters**.
- The adjacent window appears.
- Change parameters marked with (auto) where necessary to manual input with **Tv manual/auto**.
- Select the parameters to be changed with and confirm with .
- Then in the following settings window, change the value and confirm with .

**7.13.1.1 Proven settings for control parameters and pump (integral measurement probe)**

Instrument Type	Heat transfer liquid	Xp _P	Tn t <sub>n</sub>	Tv t <sub>v</sub>	Td t <sub>d</sub>	Pump Level
RP 845	Water	4.0	50	35	6	4
RP 845	Ethanol	7.0	50	35	6	4
RP 845	Ethanol	5.5	30	21	3.6	4
RP 855	Ethanol	7.0	50	35	6	4
RP 855	Ethanol	7.0	30	---	---	4
RP 855	Water	4.0	30	---	---	4
RP 855	Water-Glycol	4.0	30	---	---	4
RP 1845	Ethanol	5.5	50	40	6	5

Technical changes reserved!

**7.13.2 External control variable (External measurement probe)**

You only need to read further here if you have connected an external temperature probe or the actual temperature is read in from a module (and you have activated it as control variable according to Section 7.7.4).

Only modify the control parameters if you have knowledge of control techniques.

The control system for external actual values is implemented for improvement of the control behavior as a two-stage cascade controller. A "master controller" determines the "internal setpoint", from the temperature setpoint and the external temperature, passed to the slave controller. The control value of the slave controller controls the heating and cooling.

When a setpoint step change is specified, it may be that the optimum control would set a bath temperature, which might significantly exceed the temperature desired on the external vessel. There is a correction limitation, which specifies the maximum permissible deviation between the temperature on the external load and the heat transfer liquid temperature.

**Master**
**P Id ..**

EP 15 °C

- As shown in the menu structure (⇒ 7.6.6), the parameters for the external control variable can now be set.
- Select the parameter with or and confirm with . The set value is displayed. Adapt it with or confirm with .
- Example: Proportional factor of the master controller Kpe = 1.5.

Parameters **Master** controller (PIDT<sub>1</sub>-controller):

- **Ma** proportional factor:            EP = Kpe    as factor.
- **Ma** proportional range:           Eb = Prop\_E in kelvin.
- **Ma** reset time:                    En = Tne    in seconds.
- **Ma** derivative time (auto/man)    Ev = Tve    in seconds.  
The thermostat logic system only permits values with Tne > Tve!
- **Ma** damping time (auto/man)      Ed = Tde    in seconds.

Parameter **Slave controller (P-controller):**

- **SI** proportional range:  $\Delta P = X_{pf}$  in kelvin.
- Tve, Tde, Prop\_E changeover to Auto/ Man  
E A = automatic or E P = manual.  
Works setting is automatic. These three parameters should only be modified by experienced control technicians!

Hold  pressed for 3 seconds, then make changes.

---

- Correction limitation ELOL See introduction.

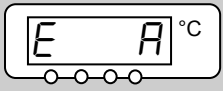







**Command** Control | Control Parameters | Control Parameters

<b>Control Parameters</b>	<b>Kpe</b> 0,50
Control para. sets	Tne 100
Tv manual/auto	Tve (auto) 83
Self Adaption	Tde (auto) 8,3
Correction limitation	Xpf 4,0
	Prop_E(a) 30

Pump	Menu	End	T <sub>set</sub>	T <sub>fix</sub>
------	------	-----	------------------	------------------

- Open the device parameter menu via the soft key  **Menu**.
- With the cursor keys continue to **Control** → **Control Parameters** → **Control Parameters**.
- The adjacent window appears. Parameter endings:  
e = Master controller, f = Slave controller.
- Where applicable change parameters marked with (auto) to manual input with **Tv manual/auto**.
- Select the parameters to be changed with  and confirm with .
- Then change the value in the following settings window and confirm with .
- **Correction limitation** see introduction.

### 7.13.2.1 Proven settings for control parameters (External measurement probe):

External vessel					Master controller (External controller)					Slave controller (Internal controller)	
Instru- ment Type	Heat transfer liquid	Description	Volu- me [L]	Hose- length [m]	Kpe <i>E<sub>P</sub></i>	Tne <i>E<sub>n</sub></i>	Tve <i>E<sub>u</sub></i>	Tde <i>E<sub>d</sub></i>	Prop_E <i>E<sub>b</sub></i>	Xpf <i>i<sub>P</sub></i>	Pump Level
RP 845	Water	double wall glass vessel	2,5	2x1	2.0	80	60	5.0	30	4.0	5
RP 855	Water	double wall glass vessel	2,5	2x1	2.0	150	130	5.0	30	3.0	5
RP 855	Water	double wall stainless steel vessel with water	0,7	2x1	0.5	70	50	5.0	30	3.0	5
RP 855	Ethanol	double wall glass vessel	2,5	2x1	2.0	150	122	15.0	30	3.0	5
RP 855	Ethanol	double wall glass vessel	2,5	2x1	2.0	150	120	15.0	30	3.0	5
RP 855	Ethanol	double wall glass vessel	2,5	2x1	2.0	125	107	15.0	30	3.0	5

Technical alterations reserved!

### 7.13.2.2 Steps for setting the control parameters for external control

1. Activate external control ⇒ 7.7.4.
2. Setting the slave controller:
  - 2.1. Set parameters to **auto**; Xpf see table (⇒ 7.13.2.1) (experienced data) depending on:
    - Check for thermostat type and change when necessary (RP....) ⇒ 9.2.1,
    - Choose heat transfer liquid with low viscosity and high thermal capacity.  
Ranking: water, ethanol, water-glycol, oil, Fluorinert®.
    - Set pump level as high as possible,
    - make bath circulation strong and fast,
    - choose hose length as short as possible, i.e. 2 x 1 m,
    - choose hose cross section as large as possible, i.e. ½ inch,
    - throughput through the external load as large as possible.
  - 2.2. Xpf setting:
    - when oscillating with short period occur (i.e. 30 seconds) → Xpf lower, otherwise higher,
    - in case of bad thermal coupling and large thermal mass → high (i.e. 2...5, or even higher),
    - in case of good thermal coupling and small thermal mass → low (i.e. 0.2 ... 0.7),
    - when rapid temperature response is required simple internal control should be preferred.  
Otherwise select small Xpf (0.05 ... 0.1).

3. Setting the master controller (PIDT<sub>1</sub>-controller):
  - Start with setting Auto and proceed with Manual only when necessary.
- 3.1. Kpe setting:
  - Start with the data from table 7.13.2.1.
  - In case of oscillations with large period, i.e.10 min) → Kpe higher, otherwise lower.
- 3.2. – Tne/ Tve/ Tde setting:
  - Start with the data from table 7.13.2.1; and with high numbers (Tne = 70 s ... 200 s; Tve = 50 s ... 150 s).
  - With lower numbers → faster approach, otherwise slower approach with lower oscillations.
  - Tve: to reduce overshoot → Tve higher, otherwise lower.
  - Tde (damping for Tve): in general approximately 10 % of Tve.
4. Correction limitation (or outflow temperature limitation) (⇒ 7.13.2.1) und temperature limits (Til/Tih) (⇒ 7.8.3):
  - Make settings in accordance with the boundary conditions. Examples:

Heat transfer liquid	Correction limitation	Til	Tih
Water	depending on the external vessel size and the thermostatic liquid	+2 °C	+95 °C
Ethanol		Minimum	+40 °C

Tools to watch the time behavior:

- Graph mode of the Command console,
- LAUDA Wintherm PC-program.

### 7.13.3 Internal and external control parameter sets

If a thermostat is used for a number of applications, which always leads to a change of the control parameters, these control parameters (up to 9 sets) can be saved in the thermostat and activated again as required.

Also saving is useful for finding the best control parameters; in this way external management of the control parameters can be avoided.

There are 9 sets (each for internal and external sets of control parameters) saved at the factory. In this menu the control parameters cannot be edited, they are only displayed.

- With **Activate** the currently valid control parameters are used.
- With **Upload actual** the actual ones are read in and saved (for later reuse).
- With **Default** the set of control parameters saved at the works is loaded again (in this case the control parameters set by the customer are lost).

Command					Control parameter sets				
<div style="border: 1px solid black; padding: 5px;">                     Control Parameters                      Control para. sets                      Tv manual/auto                      Self Adaption                      Correction limitation                 </div>	<div style="border: 1px solid black; padding: 5px;">                     Set 1                      Set 2                      Set 3                      Set 4                      Set 5                      Set 6                      Set 7                      Set 8                      Set 9                 </div>								
Pump	Menu	End	$T_{set}$	$T_{fix}$					
<div style="border: 1px solid black; padding: 5px;">                     Status                      intern                      extern                 </div>	<div style="border: 1px solid black; padding: 5px;">                     Activate                      Upload actual                      Default                 </div>								
Pump	Menu	End	$T_{set}$	$T_{fix}$					

- Open the device parameter menu via the soft key **Menu**.
- With the cursor keys continue to:  
→ **Control** → **Control Parameters** → **Control para. sets**.
- The adjacent window appears. Set 1 to Set 9.
- Select the desired set with and confirm with .
- Select the desired set to be changed with and confirm with .
- In the setting window (see left) the selected set is listed under **internal** or **external** in the display.
- Under **Status** the previously selected set:  
is activated,  
is read in and  
the set, who was saved at the factory, is restored.

### Editing the control parameter sets

The change in the control parameters is explained in Section 7.15.3 / 7.15.4 (internal / external). Once the value has been changed and confirmed, the set number, e.g. **Set 3** and **Upload actual**, the new value is accepted into the control parameter set to be changed (Set 3) via the command **Control parameter sets**.

### 7.13.4 Self Adaption (only COMMAND)

The function Self Adaption can be used to detect automatically the optimal control parameters for internal or external control.

The Self Adaption can be performed only on a device with active cooling.

This function is available from software version 2.18 of Command. For thermostats with an older software version a software update is necessary.

The Self Adaption determines the parameters by a test run of the thermostat. In this case the thermostat and, if applicable, the external application must be ready for operation. (⇒ 6).

The Self Adaption will be performed with the actually set pump step. Best results can be achieved with high pump steps.

The test run must be performed at a passive system, this means that during the test run a exo- or endothermic reaction mustn't take place.

The test run takes depending on the external application about 30 minutes to 3 hours. The bath temperature will oscillate in this time less than about ±15 Kelvin around the set temperature. After the test run the detected control parameters will be taken over as control parameters automatically.

Command	Self Adaption
<div style="border: 1px solid black; padding: 5px; margin-bottom: 5px;"> <p>Control Parameters</p> <p>Control para. sets</p> <p>Tv manual/auto</p> <p><b>Self Adaption</b></p> <p>Correction limitation</p> </div> <div style="border: 1px solid black; padding: 5px; margin-bottom: 5px;"> <p><b>Settings</b></p> </div> <div style="display: flex; justify-content: space-between; border-top: 1px solid black; border-bottom: 1px solid black; padding: 5px 0;"> <span>Pump</span> <span>Menu</span> <span>End</span> <span>T<sub>set</sub></span> <span>T<sub>fix</sub></span> </div>	<ul style="list-style-type: none"> <li>- Open the device parameter menu via the soft key  <b>Menu</b>.</li> <li>- With the cursor keys continue to: <b>Control</b> → <b>Control Parameters</b> → <b>Self Adaption</b> → <b>Settings</b>.</li> <li>- Confirm selection with .</li> </ul>
<div style="border: 1px solid black; padding: 5px; margin-bottom: 5px;"> <p><b>Status</b></p> <p>Setpoint</p> <p>Identification</p> <p>Actual Parameters</p> </div> <div style="border: 1px solid black; padding: 5px; margin-bottom: 5px;"> <p><b>Start</b></p> </div> <div style="display: flex; justify-content: space-between; border-top: 1px solid black; border-bottom: 1px solid black; padding: 5px 0;"> <span>Pump</span> <span>Menu</span> <span>End</span> <span>T<sub>set</sub></span> <span>T<sub>fix</sub></span> </div>	<ul style="list-style-type: none"> <li>- The window shown adjacent appears.</li> <li>- With the menu <b>Status</b> the test run of the Self Adaption can be started. When the Self Adaption is finished, the test run will be terminated automatically.</li> <li>- As soon as start  is pressed, in the sofkey area the information <b>Adaption on</b> will be displayed followed by the actual status of the test run.</li> </ul>



<div style="border: 1px solid black; padding: 5px;"> <p>Status</p> <p style="border: 1px solid black; display: inline-block; padding: 2px;">Setpoint</p> <p>Identification</p> <p>Actual Parameters</p> </div>	<div style="border: 1px solid black; padding: 5px; text-align: center;"> <p style="font-size: 1.2em;">30,00°C</p> </div>	<ul style="list-style-type: none"> <li>- With the menu <b>Setpoint</b> the set temperature for the test run can be set. The bath temperature will oscillate less than about ±15 Kelvin around the set temperature.</li> <li>- Change the display in the adjacent window and accept with .</li> </ul>					
<table border="1" style="width: 100%; border-collapse: collapse;"> <tr> <td style="padding: 2px 5px;">Pump</td> <td style="padding: 2px 5px;">Menu</td> <td style="padding: 2px 5px;">End</td> <td style="padding: 2px 5px;">T<sub>set</sub></td> <td style="padding: 2px 5px;">T<sub>fix</sub></td> </tr> </table>	Pump	Menu	End	T <sub>set</sub>	T <sub>fix</sub>		
Pump	Menu	End	T <sub>set</sub>	T <sub>fix</sub>			
<div style="border: 1px solid black; padding: 5px;"> <p>Status</p> <p style="border: 1px solid black; display: inline-block; padding: 2px;">Setpoint</p> <p style="border: 1px solid black; display: inline-block; padding: 2px;">Identification</p> <p>Actual Parameters</p> </div>	<div style="border: 1px solid black; padding: 5px; text-align: center;"> <p style="font-size: 1.2em;">intern</p> <p>intern + extern</p> </div>	<ul style="list-style-type: none"> <li>- With the menu <b>Identification</b> the optimal control parameters for internal control or for the internal control and the external control can be detected automatically. To detect the control parameters for the external application, a temperature probe must be connected to the thermostat.</li> </ul>					
<table border="1" style="width: 100%; border-collapse: collapse;"> <tr> <td style="padding: 2px 5px;">Pump</td> <td style="padding: 2px 5px;">Menu</td> <td style="padding: 2px 5px;">End</td> <td style="padding: 2px 5px;">T<sub>set</sub></td> <td style="padding: 2px 5px;">T<sub>fix</sub></td> </tr> </table>	Pump	Menu	End	T <sub>set</sub>	T <sub>fix</sub>		
Pump	Menu	End	T <sub>set</sub>	T <sub>fix</sub>			
<div style="border: 1px solid black; padding: 5px;"> <p>Status</p> <p style="border: 1px solid black; display: inline-block; padding: 2px;">Setpoint</p> <p>Identification</p> <p style="border: 1px solid black; display: inline-block; padding: 2px;">Actual Parameters</p> </div>	<div style="border: 1px solid black; padding: 5px; text-align: center;"> <p style="font-size: 1.2em;">Store in Set 9</p> </div>	<ul style="list-style-type: none"> <li>- With the menu <b>Actual Parameters</b> the actual set control parameters can be stored in parameter set 9. After the test run the detected control parameters will be taken over as control parameters automatically. If the parameters found do not fulfil your expectations, the before set parameters can be restored (⇒ 7.13.3).</li> </ul>					
<table border="1" style="width: 100%; border-collapse: collapse;"> <tr> <td style="padding: 2px 5px;">Pump</td> <td style="padding: 2px 5px;">Menu</td> <td style="padding: 2px 5px;">End</td> <td style="padding: 2px 5px;">T<sub>set</sub></td> <td style="padding: 2px 5px;">T<sub>fix</sub></td> </tr> </table>	Pump	Menu	End	T <sub>set</sub>	T <sub>fix</sub>		
Pump	Menu	End	T <sub>set</sub>	T <sub>fix</sub>			

### 7.14 Alarms, Warnings and Errors

The SelfCheck Assistant of your Proline Thermostat monitors more than 50 device parameters and triggers alarms, warnings or errors as appropriate.

All warnings and alarms are shown on the Command Console in plain text. Errors are shown in plain text on the Command Console in an error list.



**Alarms:** Alarms are safety relevant. Pump, heater and refrigerating unit will be shut off.

**Warnings:** Warnings normally are not safety relevant. The thermostat continues to operate.

**Errors:** When an error occurs switch of the device. If the error is always present after switching on the device, please inform the LAUDA Service (⇒ 9.4).

Find cause of alarm or warning and rectify where necessary. Then press  on the Master keyboard in order to remove the alarm message. Warning messages can be removed either on the Master keyboard

with  or on the Command board with .

Warnings may be ignored by pressing  or  on the Master keyboard or by activating the Screen Softkey on the Command Console. Otherwise, warnings will be repeated periodically.

#### 7.14.1 Overtemperature protection and checking



The units are designed for operation with non-flammable and flammable liquids to DIN EN 61010-2-010.



Setting the overtemperature cut-off: Recommended setting: 5 °C above desired bath temperature.





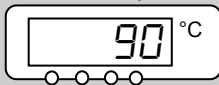

**Caution!!** The overheat switch-off point  $T_{max}$  is controlled by a system functioning independently of the bath control. Setting of the nominal temperature, however, can be limited via the functions  $T_{in}$  and  $T_{il}$  (⇒ 7.8.3) independently of  $T_{max}$ .

- The cut-off point is displayed in the LED display on pressing the  key.

Overtemp. cut-off









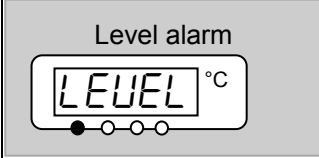

Changing the overtemperature cut-off point:

- For safety, and to guard against unintentional adjustment, the key  must be held pressed during all the following entries. Now, briefly press . The display flashes and the overtemperature cut-off can be set with the keys  or .
- Quit the change mode by pressing  for a few seconds or automatically after 5 seconds, while you keep  pressed.
- This somewhat complicated procedure is intended to prevent unintentional adjustment.



### 7.14.2 Low-level alarm and low-level checking

    	<p>If the liquid level falls so far that the heating element is no longer completely covered with liquid, an alarm is initiated:</p> <ol style="list-style-type: none"> <li>1. The alarm sounds as a dual-tone signal.</li> <li>2. Display for <i>LEVEL</i> (low level) is shown when the bath contains too little liquid.</li> <li>3. The red LED  above the fault triangle  flashes.             <ul style="list-style-type: none"> <li>→ Heater switches off on both poles;</li> <li>→ Varioflex pump and refrigerating unit are switched off.</li> </ul> </li> </ol> <ul style="list-style-type: none"> <li>– Find the cause of the fault and, where necessary, top up for missing liquid (⇒ 6.2 and 6.3).</li> <li>– Press the Enter key.</li> <li>– Also, press this key if the unit has been switched off in the fault state.</li> </ul> <p>– <b>Checking the safety system at regular intervals</b> by lowering the bath level. To do this, push hose onto pump connector and pump heat transfer liquid into a suitable vessel.</p> <p>– Step 1 – 2 must follow.</p>
	<ul style="list-style-type: none"> <li>– With this test, the bath temperature must not be below 0 °C or above max. 50 °C, otherwise there is a risk of burning!</li> <li>– If irregularities arise during the checking of the safety devices, switch off the unit immediately and pull out the mains plug.</li> <li>– Have the equipment checked by LAUDA Service Constant Temperature Equipment.</li> </ul>
<b>Command</b>	<div style="border: 1px solid black; padding: 2px; display: inline-block;">Low-level alarm!</div>
	<ul style="list-style-type: none"> <li>– <div style="border: 1px solid black; padding: 2px; display: inline-block;">Low-level alarm</div> is shown in the display and signifies that <u>unlocking is only possible on the Master control panel.</u></li> </ul>

### 7.14.3 High-level settings

Different reactions can be chosen when the level sensor detects the height of the heat transfer liquid level. Depending on the setup, heat transfer liquid or operation conditions, one of the following settings may be suitable:

Setting	Master settings	Command settings	Reaction and application recommendation
No warning	nHnon	<b>none</b>	Select only when no safety sensitive application. I.e. water as heat transfer liquid.
Warning	nHLLJ	<b>Warning</b>	Acoustic and optical warning as long as the level goes down. This is the factory setting.
Warning and heater off	nHLLJH	<b>Warning + heater off</b>	Warning and additional heater off as long as the level goes down. Recommended for flammable heat transfer liquids with much higher flash point and temperatures above 100 °C.
Alarm	nHALLA	<b>Alarm</b>	Alarm switches off the pump and the heater until the alarm is removed by pressing  on the Master keyboard. Recommended for external loads and flammable liquids.

**Master**
nHLLJ

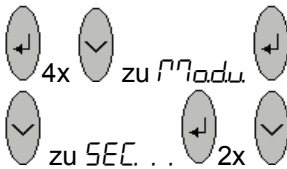

- Choose the menu for the high-level reaction.
- The factory setting is nHLLJ. That is a warning.

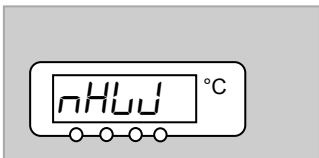

- Press  to enter the setup mode. The current setting flashes.
- Choose a setting from the above list.

**Command**
**Over level handling**





Over level handling

none

**Warning**







Warn.+ Heater off

Alarm

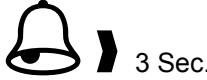

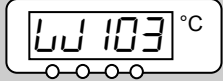
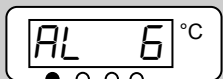





- Open the device parameter menu via the soft key  **Menu**.
- With the cursor keys continue to → **Settings** → **Over level handling**.
- The shown window appears
- Select the preferred parameter with  or  and confirm with .
- See introduction for details.

Pump
Menu
End
T<sub>set</sub>
T<sub>fix</sub>









### 7.14.4 High-level warning or alarm

	<ul style="list-style-type: none"> <li>- Acoustic warning signal sounds for 3 seconds when the liquid level rises so far that the uppermost switching point of the level sensor has been reached.</li> </ul>			
	<p>Or in case the warning function as described in 7.14.3 was chosen:</p> <ul style="list-style-type: none"> <li>- The acoustic signal with dual-tone sounds.</li> </ul>			
<p>Level warning</p> 	<ul style="list-style-type: none"> <li>- Warning <i>LWArn 103</i> (high level) appears when the bath contains too much liquid.</li> <li>- The <i>LWArn</i> flashes by turns with the numeral.</li> </ul>			
<p>Level alarm</p> 	<p>In case the alarm function as described in 7.14.3 was chosen:</p> <ul style="list-style-type: none"> <li>- The acoustic signal with dual-tone sounds.</li> <li>- The red LED  above the fault triangle  flashes. <ul style="list-style-type: none"> <li>→ Heater switches off on both poles,</li> <li>→ Pump and refrigerating unit are switched off electronically.</li> </ul> </li> </ul>			
	<ul style="list-style-type: none"> <li>- Find the cause of the fault. Possible causes may be: <ol style="list-style-type: none"> <li>1. Volume expansion on heating.</li> <li>2. Feed to an external vessel may be interrupted so that only return suction is possible.</li> <li>3. Heat transfer liquid taking up moisture.</li> </ol> </li> <li>- If Alarm: Press Enter key. Warnings disappear automatically when the cause is gone.</li> <li>- Also, press this key if the unit has been switched off in the fault state. Warnings disappear automatically when the cause is gone.</li> </ul>			
<p><b>Command</b></p>	<p>High-level warning/alarm</p>			
	<ul style="list-style-type: none"> <li>- The display shows <table border="1" data-bbox="635 1384 1090 1451"> <tr> <td>Warning. To release press Enter key</td> </tr> <tr> <td>Security 3 Level too high</td> </tr> </table> <p>or</p> <table border="1" data-bbox="635 1473 1090 1518"> <tr> <td>Alarm AL 6: Level too high</td> </tr> </table> is shown in the display and signifies that <u>unlocking is only possible on the Master control panel.</u> </li> </ul>	Warning. To release press Enter key	Security 3 Level too high	Alarm AL 6: Level too high
Warning. To release press Enter key				
Security 3 Level too high				
Alarm AL 6: Level too high				

**7.14.5 Pump-motor supervision: Overload or blockage**

 <div style="border: 1px solid gray; padding: 5px; margin: 5px 0;"> <p style="text-align: center;">Pump alarm</p>  </div>   	<p>The SelfCheck Assistant monitors the Varioflex Pump:</p> <ol style="list-style-type: none"> <li>1. Alarm sounds as dual-tone signal for pump-motor overload or blockage.</li> <li>2. Display of <i>bLOC</i> signals blockage.</li> <li>3. The red LED  above the fault triangle  flashes.             <ul style="list-style-type: none"> <li>→ Heater switches off on both poles,</li> <li>→ Pump and refrigerating unit are switched off electronically.</li> </ul> </li> </ol> <ul style="list-style-type: none"> <li>– Find the cause of the fault. Perhaps the viscosity of the heat transfer liquid is too high or the pump is blocked.</li> <li>– Press the Enter key.</li> <li>– Also press this key if the unit has been switched off in the fault state.</li> </ul>
<p><b>Command</b></p>	<p>Pump-motor alarm!</p>
	<ul style="list-style-type: none"> <li>– <span style="border: 1px solid gray; padding: 2px;">Pump-motor alarm</span> is shown in the display and signifies that <u>unlocking is only possible on the Master control panel</u>.</li> </ul>

**7.14.6 Pump-motor supervision: Dry running**

 <div style="border: 1px solid gray; padding: 5px; margin: 5px 0;"> <p style="text-align: center;">Pump alarm</p>  </div>    <p>The cause of the failure of the level measurement with the floatation sensor must be found and rectified. Perhaps it is blocked by foreign bodies in the bath.</p> 	<p>The SelfCheck Assistant monitors the Varioflex pump:</p> <ol style="list-style-type: none"> <li>1. Alarm sounds as dual-tone signal when the pump runs without liquid. This can only occur when the float level measurement has failed.</li> <li>2. The display of <i>PULEU</i> signals that the SelfCheck Assistant has detected a pump low level.</li> <li>3. The red LED  above the fault triangle  flashes.             <ul style="list-style-type: none"> <li>→ Heater switches off on both poles,</li> <li>→ Pump and refrigerating unit are switched off electronically.</li> </ul> </li> </ol> <ul style="list-style-type: none"> <li>– Press the Enter key.</li> <li>– Also press this key if the unit has been switched off in the fault state.</li> </ul>
<p><b>Command</b></p>	<p>Alarm! Low level (pump)</p>
	<ul style="list-style-type: none"> <li>– <span style="border: 1px solid gray; padding: 2px;">Alarm! Low level (pump)</span> is shown in the display and signifies that <u>unlocking is only possible on the Master control panel</u>.</li> </ul>

### 7.14.7 Fault list „Alarms and Warnings“

#### Alarms

Message	Meaning
PJLEU	Pump too fast (low level)
LEUEL	Low level alarm in the level sensor
TEPNP	Overtemperature (t > tmax)
BLOC	Pump blocked (no rotation)
CFR IL	Command connection interrupt
AL 1	Temperature signal of external Pt100 missing
AL 2	Temperature signal of analogue input missing
AL 3	Temperature signal of serial port missing
AL 4	Analogue module: Current input 1 interrupted
AL 5	Analogue module: Current input 2 interrupted
AL 6	Protection system: High bath level
AL 7	Error digital input (from V 1.30 on)
AL 8	Refill fail

#### Warnings in the “Master-Display”

Message	Meaning
LJ 1	Overflow of CAN receipt
LJ 2	Watchdog-Reset
LJ 3	til-limitation active
LJ 4	tih-limitation active
LJ 5	Heatsink temperature
LJ 11	Software version of protection system too old
LJ 12	Software version of operating system too old
LJ 13	Software version of heating system too old
LJ 14	Software version of analogue Interface too old
LJ 15	Software version of RS 232 too old
LJ 16	Software version of contact I/O module too old
LJ 17	Software version of valve 0 too old
LJ 18	Software version of valve 1 too old
LJ 19	Software version of valve 2 too old
LJ 20	Software version of valve 3 too old
LJ 21	Software version of pump 0 too old
LJ 22	Software version of pump 1 too old
LJ 23	Software version of pump 2 too old
LJ 24	Software version of pump 3 too old

#### Warnings in the “Safety system”

Message	Meaning
LJ 101	Overflow of CAN receipt
LJ 102	Watchdog-Reset
LJ 103	Close to bath overflow
LJ 104	Bath level is approaching switch off level or is out of optional range
LJ 105	Heater 1 break
LJ 106	Heater 2 break
LJ 107	Heater 3 break
LJ 110	Software version of control system too old
LJ 112	Software version of operating system too old
LJ 113	Software version of heating system too old
LJ 114	Software version of analogue interface too old
LJ 115	Software version of RS 232 too old
LJ 116	Software version of contact I/O module too old
LJ 117	Software version of valve 0 too old
LJ 118	Software version of valve 1 too old
LJ 119	Software version of valve 2 too old
LJ 120	Software version of valve 3 too old
LJ 121	Software version of pump 0 too old
LJ 122	Software version of pump 1 too old
LJ 123	Software version of pump 2 too old
LJ 124	Software version of pump 3 too old





### Warnings from "Contact I/O-Module"

Message	Meaning
LL601	Overflow of CAN receipt
LL602	Watchdog-Reset
LL610	Software version of control system too old
LL611	Software version of protection system too old
LL612	Software version of operation system
LL613	Software version of heating system too old
LL614	Software version of analogue interface too old
LL615	Software version of RS232 too old
LL617	Software version of valve 0 too old
LL618	Software version of valve 1 too old
LL619	Software version of valve 2 too old
LL620	Software version of valve 3 too old
LL621	Software version of pump 0 too old
LL622	Software version of pump 1 too old
LL623	Software version of pump 2 too old
LL624	Software version of pump 3 too old

### Warnings from "Solenoid valve" Code 7, 8, 9XX)

Message	Meaning
LL701	Overflow of CAN receipt
LL702	Watchdog-Reset
LL710	Software version of control system too old
LL711	Software version of protection system too old
LL712	Software version of operation system
LL713	Software version of heating system too old
LL714	Software version of analogue interface too old
LL715	Software version of RS232 too old
LL716	Software version of contact I/O too old
LL721	Software version of pump 0 too old
LL722	Software version of pump 1 too old
LL723	Software version of pump 2 too old
LL724	Software version of pump 3 too old

## 8 Interfaces - Modules

### 8.1 Installing of modules

The master and command can be supplemented with further interface modules, which are simply inserted at the back of the control head into two module slots.

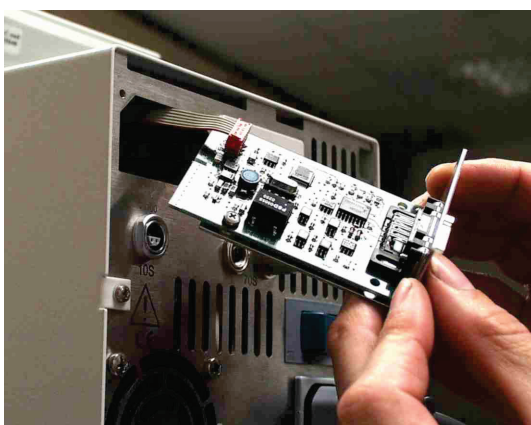

- Touch the earthed bath cover of the Proline thermostat to discharge any electrostatic charge.
- Remove the module from its packaging.
- Switch off the thermostat and pull out the mains plug.
- Insert a screwdriver into the lower recess of the module cavity and prise up the plastic cover. The cover can then be pulled off downwards.
- Pull out the plug of the bus connecting cable from the plastic cover.
- Plug on the bus connecting cable (red plug onto red socket).
- Insert the module and secure with the two crosshead screws.
- Connect the mains plug again and switch on the thermostat.



The plugs are protected against reverse polarity. The plugs have a ridge, which slides into a groove in the socket.



### 8.3 Serial interfaces RS232/485

RS232/485 Interface Module (catalogue no. LRZ 913) with 9-pole SUB-D socket. Electrically isolated by optocoupler. With the LAUDA instruction set essentially compatible to the ECO, Ecoline and Integral Series. The RS232 interface can be connected directly to the PC with a 1:1 through-contact cable (catalogue no. EKS 037).

#### 8.3.1 Menu structure for RS232/485 Interface Module (Master)

All existing menu points are illustrated. However, the Master unit masks out menu points which cannot be executed.

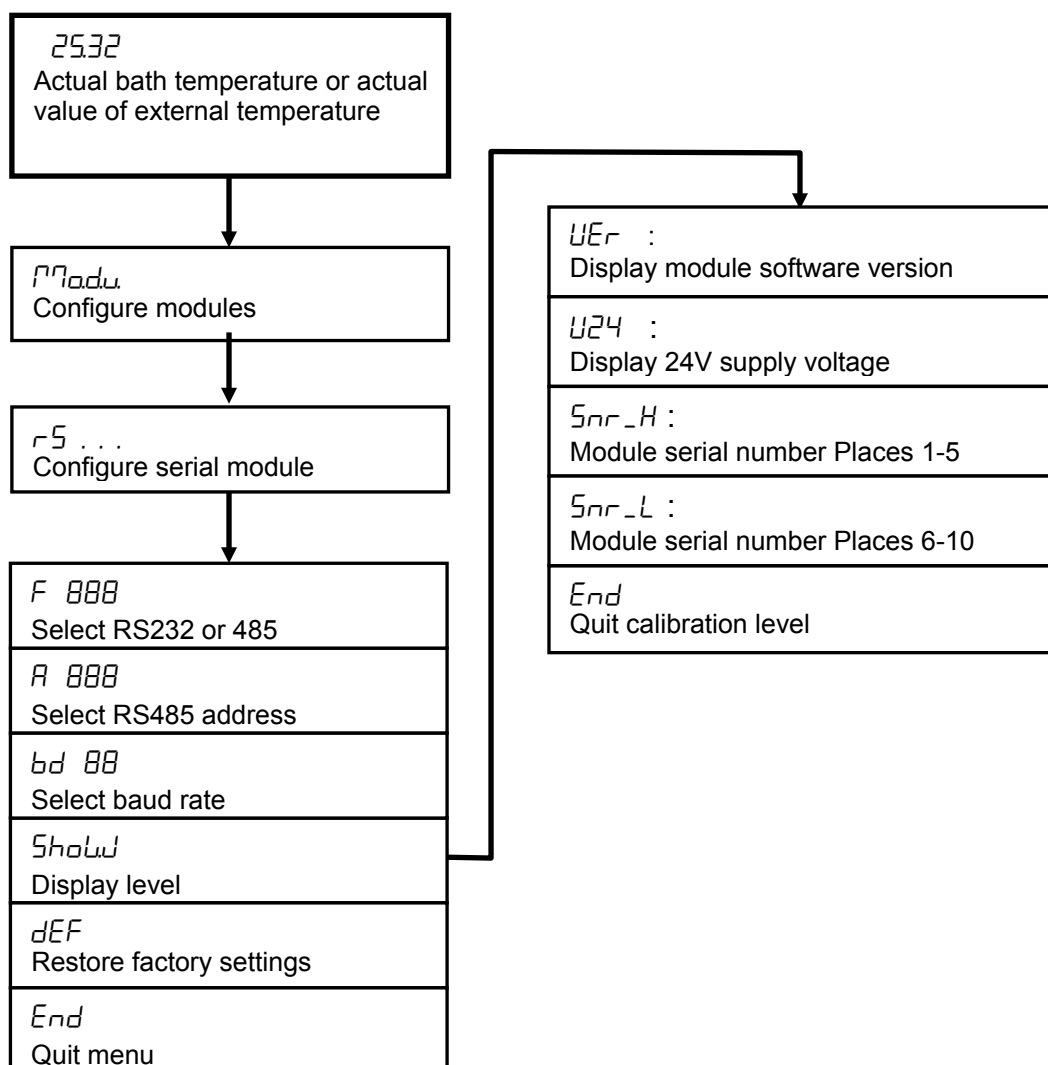

### 8.3.2 Connecting cables and interface test RS232

Signal	Computer				Thermostat		Signal
	9-pin sub-D-socket		25-pin sub-D-socket		9-pin sub-D-socket		
	①	②	①	②	①	②	
R x D	2	2	3	3	2	2	T x D
T x D	3	3	2	2	3	3	R x D
DTR	4		20		4		DSR
Signal Ground	5	5	7	7	5	5	Signal Ground
DSR	6		6		6		DTR
RTS	7		4		7		CTS
CTS	8		5		8		RTS

① with hardware handshake: For connecting a thermostat to the PC use 1:1 cable and not a null-modem cable!

② without hardware handshake: the computer / PC must be set to the operating mode “without hardware handshake”.



- Use screened connecting cable.
- Connect screen to connector case.
- The connections are isolated from the remainder of the electronics.
- Any pins not in use must not be connected!

When a PC is connected up the RS232 interface can easily be **tested** using the Microsoft Windows operating system.

On Windows® 3.11 with the “Terminal” program.

On Windows® 95/ 98/ NT/ XP with the “Hyper Terminal” program.

“HyperTerminal” no longer part of the operating system in Windows Vista, Windows 7 and Windows 8.

- With the LAUDA software “Wintherm Plus” (catalogue number LDSM2002) the RS232 interface can be addressed.
- In the internet, there are terminal programs available as freeware. These programs offer similar functions as “HyperTerminal” (for example PuTTY). Search for “serial port terminal program”.

### 8.3.3 Protocol RS232



- The interface operates with one stop bit, no parity bit and 8 data bits.
- Transfer rate either 2400, 4800, 9600 (factory setting) or 19200 baud as selected.
- The RS232 interface can be operated with or without hardware handshake, (RTS/CTS).
- The command from the computer must be terminated with CR, CRLF, or LFCR.
- The response of the thermostat is always terminated with CRLF.

CR = Carriage Return (Hex: 0D)

LF = Line Feed (Hex: 0A)

**Example:** Transfer of setpoint 30,5 °C to the thermostat

Computer	Thermostat
"OUT_SP_00_30.5"CRLF	⇒
⇐	"OK"CRLF

### 8.3.4 Connecting cable RS485

Thermostat	
9-pin sub-D-socket	
Pin	Data
1	Data A (-)
5	SG (Signal Ground) optional
6	Data B (+)



- Use screened connecting cables.
- Connect screen to connector case.
- The connections are isolated from the remainder of the electronics.
- Any pins not in use must not be connected!

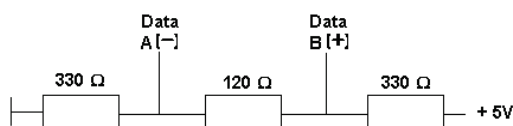

An **RS485** bus always requires bus termination in the form of a termination network, which ensures a defined rest status in the high-resistance phases of bus operation. The bus termination is as follows:

This termination network is usually incorporated on the PC plug-in card (RS485).

### 8.3.5 Protocol RS485



- The interface operates with one stop bit, no parity bit and 8 data bits.
- Transfer rate either 2400, 4800, 9600 (Factory setting) or 19200 baud as selected.
- The RS485 commands are always preceded by the device address. There is provision for 127 addresses. The address must always have three digits. (A000\_...to A127\_...)
- The command from the computer must be terminated with CR.
- The response of the thermostat is always terminated with CR.

CR = Carriage Return (Hex: 0D)

**Example:** Transfer of setpoint 30.5 °C to the thermostat with address 15.

Computer	Thermostat
"A015_OUT_SP_00_30.5"CR	⇒
⇐	"A015_OK"CR

### 8.3.6 Write commands (Data commands to the thermostat)

Command	Explanation
OUT_PV_05_XXX.XX	External temperature to be set through the interface.
OUT_SP_00_XXX.XX	Setpoint transfer with up to 3 places before the decimal point and up to 2 places behind.
OUT_SP_01_XXX	Pump output step 1 to 8.
OUT_SP_02_XXX	Operation mode cooling (0 = OFF / 1 = ON / 2 = AUTOMATIC).
OUT_SP_04_XXX	TiH outflow temperature limit, high limit.
OUT_SP_05_XXX	TiL outflow temperature limit, low limit.
OUT_PAR_00_XX.X	Setting of control parameter Xp.
OUT_PAR_01_XXX	Setting of control parameter Tn (5...180 s; 181 = Off).
OUT_PAR_02_XXX	Setting of control parameter Tv.
OUT_PAR_03_XX.X	Setting of control parameter Td.
OUT_PAR_04_X.XX	Setting of control parameter KpE.
OUT_PAR_05_XXX	Setting of control parameter TnE (0...979 s; 980 = Off).
OUT_PAR_06_XXX	Setting of control parameter TvE (0 = Off).
OUT_PAR_07_XX.X	Setting of control parameter TdE.
OUT_PAR_09_XXX.X	Setting of the correction limitation.
OUT_PAR_10_XX.X	Setting of control parameter XpF.
OUT_PAR_14_XXX.X	Setting of the setpoint offset.
OUT_PAR_15_XXX	Setting of control parameter PropE
OUT_MODE_00_X	Keyboard Master: 0 = free / 1 = locked (corresponds to "KEY").
OUT_MODE_01_X	Control: 0 = internal / 1 = external Pt100 / 2 = external Analogue / 3 = external Serial.
OUT_MODE_03_X	Keyboard Command: 0 = free / 1 = locked.
OUT_MODE_04_X	Setpoint offset source: 0 = normal / 1 = external Pt / 2 = external analogue / 3 = external serial.
START	Switches the unit on (after Standby). <b>See safety information</b> (⇒ 7.7.3).
STOP	Switches the unit into Standby (pump, heater, cooling unit OFF).
RMP_SELECT_X	Selection of the program (1...5) to which the further instructions apply. When the unit is switched on, program 5 is selected automatically.
RMP_START	Start the programmer.
RMP_PAUSE	Hold (pause) the programmer.
RMP_CONT	Restart the programmer after pause.
RMP_STOP	Terminate the program.
RMP_RESET	Delete the program (all Segments).
RMP_OUT_00_XXX.XX_XXXXX_XXX.XX_X	Set a programmer segment (temperature, time, tolerance and pump level). A segment is added and appropriate values are applied to it.
RMP_OUT_02_XXX	Number of times the program runs: 0 = unlimited / 1...250.





- For " " use also " " (blank character).
- Response from thermostat "OK" or in case of error "ERR\_X" (RS485 interface e.g. "A015\_OK" or in case of error "A015\_ERR\_X").

**Permitted data formats:**

-XXX.XX	-XXX.X	-XXX.	-XXX	XXX.XX	XXX.X	XXX.	XXX
-XX.XX	-XX.X	-XX.	-XX	XX.XX	XX.X	XX.	XX
-X.XX	-X.X	-X.	-X	X.XX	X.X	X.	X
-.XX	-.X	.XX	.X				

**8.3.7 Read commands (Data requested from the thermostat)**

Command	Explanation
IN_PV_00	Read bath temperature (outflow temperature).
IN_PV_01	Indication of the controlled temperature (internal/ external Pt / external analogue / external serial).
IN_PV_03	Read external temperature TE (Pt100).
IN_PV_04	Read external temperature TE (analogue input).
IN_PV_05	Read bath level.
IN_PV_10	Read bath temperature (outflow temperature) <b>in 0.001 °C.</b>
IN_PV_13	Read external temperature TE (Pt100) <b>in 0.001 °C.</b>
IN_SP_00	Read temperature setpoint.
IN_SP_01	Read current pump power stage.
IN_SP_02	Read cooling operation mode (0 = OFF / 1 = ON / 2 = AUTOMATIC).
IN_SP_03	Read current overtemperature switch-off point.
IN_SP_04	Read current outflow temperature limit TiH.
IN_SP_05	Read current outflow temperature limit TiL.
IN_PAR_00	Read current value of Xp.
IN_PAR_01	Read current value of Tn (181 = OFF).
IN_PAR_02	Read current value of Tv.
IN_PAR_03	Read current value of Td.
IN_PAR_04	Read current value of KpE.
IN_PAR_05	Read current value of TnE (980 = OFF).
IN_PAR_06	Read current value of TvE (0 = OFF).
IN_PAR_07	Read current value of TdE.
IN_PAR_09	Read current value of correction limitation
IN_PAR_10	Read current value of XpF.
IN_PAR_14	Read setpoint offset.
IN_PAR_15	Read current value of PropE.
IN_DI_01	State of contact input 1: 0 = open / 1 = closed.
IN_DI_02	State of contact input 2: 0 = open / 1 = closed.
IN_DI_03	State of contact input 3: 0 = open / 1 = closed.
IN_DO_01	State of Contact output 1: 0 = make-contact open / 1 = make-contact closed.
IN_DO_02	State of Contact output 2: 0 = make-contact open / 1 = make-contact closed.
IN_DO_03	State of Contact output 3: 0 = make-contact open / 1 = make-contact closed.

Command	Explanation
IN_MODE_00	Keyboard Master: 0 = free / 1 = inhibited.
IN_MODE_01	Control: 0 = internal / 1 = external Pt100 / 2 = external analogue / 3 = external serial
IN_MODE_02	Standby: 0 = Unit ON / 1 = Unit OFF.
IN_MODE_03	Keyboard Command: 0 = free / 1 = inhibited.
IN_MODE_04	Setpoint offset source: 0 = normal / 1=external Pt / 2 = external analogue / 3 = external serial
TYPE	Read the device type (for example "RP 845").
VERSION_R	Read software version number of control system.
VERSION_S	Read software version number of protection system.
VERSION_B	Read software version number of Command.
VERSION_T	Read software version number of cooling system.
VERSION_A	Read software version number of analogue module.
VERSION_V	Read software version number of RS232/485 module.
VERSION_D	Read software version number of digital module.
VERSION_M_0	Read software version number of solenoid valve (Cooling water).
VERSION_M_1	Read software version number of solenoid valve (Automatic refill).
VERSION_M_3	Read software version number of solenoid valve (shut-off valve 1).
VERSION_M_4	Read software version number of solenoid valve (shut-off valve 2).
VERSION_M_5	Read software version number of high-temperature cooler.
STATUS	Read equipment status 0 = OK, -1 = error.
STAT	Read error diagnosis Response: XXXXXXXX → X = 0 no error, X = 1 error. 1 Char = error. 2 Char = Alarm. 3 Char = Warning. 4 Char = over temperature. 5 Char = low-level error. 6 Char = high-level error (at adjustment alarm). 7 Char = no external control variable.
RMP_IN_00_XXX	Read a program segment XXX (response: e. g. "030.00_00010_005.00_001.00" => set point temperature 30.00 °C, time = 10 min, tolerance = 5.00 K, pump level = 1).
RMP_IN_01	Read current segment number.
RMP_IN_02	Read set number of program runs.
RMP_IN_03	Read current program run.
RMP_IN_04	Read the program to which further instructions apply.
RMP_IN_05	Read which program is running now (0 = none).
LOG_IN_00_XXXX	Read measuring point XXXX from data logger (Reply: e. g. 020.00_021.23_030.50 → set point temperature = 20.00 °C, bath temperature = 21.23 °C, external temperature = 30.5 °C).
LOG_IN_01	Read all measuring points from data logger. As a difference to the command "LOG_IN_00", a tabulator is used here as separator instead of ',' . The measuring points are separated by CR and LF. The end is marked by CR LF CR LF.
LOG_IN_02	Read start time from the data logger (Reply: e.g. 20_14_12_20 → day 20, time 14:12:20).
LOG_IN_03	Read acquisition interval from the data logger (Reply in seconds).



- For ”\_“ use also ” ” (blank character).
- The equipment response is always in the fixed decimal format ”XXX.XX“ or for negative values ”-XXX.XX“ or ” ERR\_X“. (RS485 interface e.g.. ”A015\_ XXX.XX“ or ”A015\_-XXX.XX“ or ”A015\_ERR\_X“).

### 8.3.8 Error messages

Message	Explanation
ERR_2	Wrong input (e.g. buffer overflow)
ERR_3	Wrong command
ERR_5	Syntax error in value
ERR_6	Illegal value
ERR_8	Module (ext. temperature) not available
ERR_30	Programmer, all segments occupied.
ERR_31	Set point not possible, analogue set point input ON.
ERR_32	$T_{iH} \leq T_{iL}$ .
ERR_33	No external sensor
ERR_34	Analogue value not available
ERR_35	Auto is selected
ERR_36	No set point input possible. Programmer is running or paused.
ERR_37	No start from programmer possible, analogue setpoint input is switched on.

### 8.3.9 Driver software for LABVIEW®

An individual, easy-to-use control and automation software for operating the PROLINE device can be programmed with the aid of the National Instruments program development tool LABVIEW® (<http://sine.ni.com/apps/we/nioc.vp?cid=1381&lang=US>).

In order to make program operation possible on the RS232/485 interface, LAUDA provides drivers specially designed for LABVIEW® which can be downloaded free of charge under [www.lauda.de/spec-e.htm](http://www.lauda.de/spec-e.htm).



**Connection of the analogue inputs and outputs**

A 6-pole round connector with screw locking and contact arrangement according to DIN EN 60130-9 or IEC 130-9 is needed.

A suitable coupling plug can be obtained under catalogue no. EQS 057.

View of the socket (front) or solder side of plug:

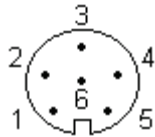

Socket 74S (from May 2010 on)

- Pin 1 Output 1
- Pin 2 Output 2
- Pin 3 0 V reference potential
- Pin 4 Input 1
- Pin 5 +20 V (max. 0.1 A)**
- Pin 6 Input 2

Socket 71S (till end 2006)

- Pin 1 Output 1
- Pin 2 Output 2
- Pin 3 0 V reference potential
- Pin 4 Input 1
- Pin 5 0 V reference potential**
- Pin 6 Input 2

Socket 74S (from 2007 on till April 2010)

- Pin 1 Output 1
- Pin 2 Output 2
- Pin 3 0 V reference potential
- Pin 4 Input 1
- Pin 5 +24 V (max. 0.1 A)**
- Pin 6 Input 2



Use shielded lines. Connect shielding with connector housing!

### 8.4.1 Menu structure Analogue module (Master)

All existing menu points are illustrated. However, the Master unit masks out menu points which cannot be executed.

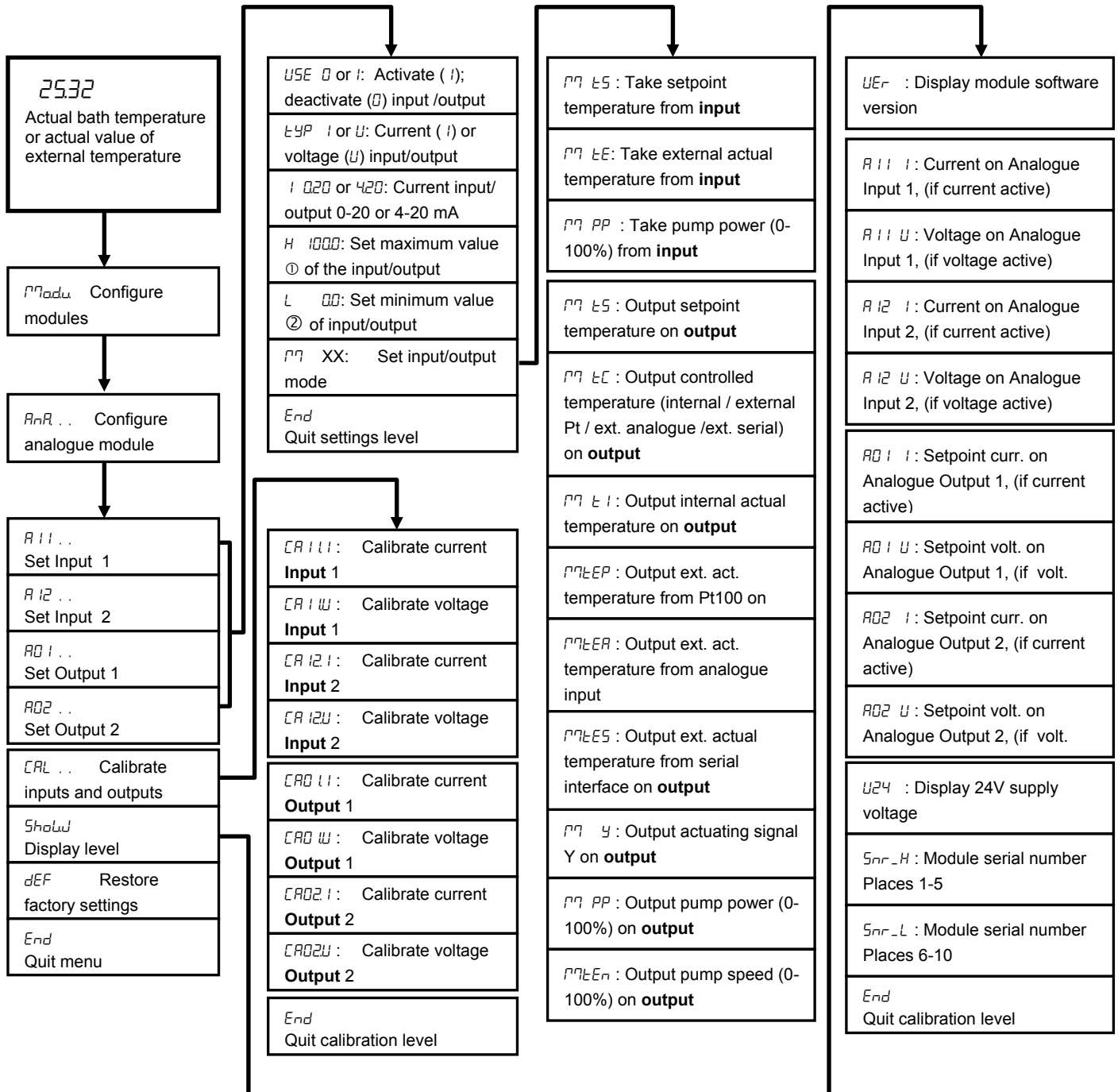

① corresponds to 20mA or 10V

② corresponds to 0mA, 4mA or 0V

## 8.5 Contact module

### 8.5.1 Contact module LRZ 915 with three inputs and three outputs

Contact module Cat. no. LRZ 915) on 15 pole SUB-D socket. With three relay contact outputs (changeover, maximum 30 V/ 0.2 A) and three binary inputs for control via external voltage-free contacts.

The following functions are made available by the inputs:

- Set fault with function: Master: *F ALA* or Command: **Fault**.
- Set Stand by with function: *F Stb* or **Stand by**.
- Control programmer (Input 1 activates programmer 1, input 2 activates programmer 2 etc. At the first "close" the programmer gets starting, "open" removes it in "pause". The next "close" initiate "continue") with function: *F PrB* or **Programmer**.
- Control alternating mode (the switching state contact "open" or "closed" allot to two different setpoint temperatures): *F t2C* or **alternating mode**.
- Controller mode (the switching state input "open" or "closed" can allotted to two different control temperature sources. E. g. internal ↔ external control): *F Con* or **type of control**.

The following functions are made available by the outputs:

- Signal various fault states: *F d iA* or **fault diagnosis**.
- Signaling standby: *F Stb* or **Standby**.
- Providing status of the window discriminators (inside ↔ outside): *F Ud i* or **temperature range**.
- Providing the programmer status: *F PrB* or **Programmer**.
- Signaling refill of heat transfer liquid: *F F iL* or **Refill**.

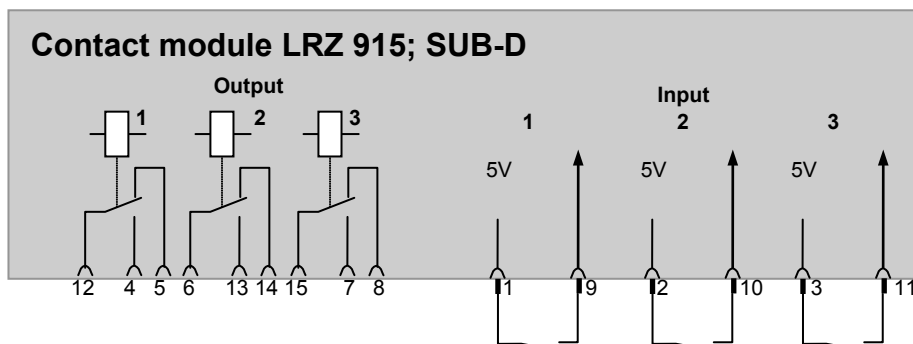

#### Contact inputs and outputs

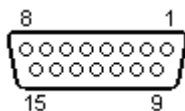

- View of the socket from the plug side or of the plug on the solder side.
- A suitable 15-pole Sub-D plug can be obtained together with a suitable housing: Catalogue no. EQM 030 and plug housing catalogue no. EQG 017.

## 8.5.2 Namur-Contact module LRZ 914 with only one input and one output

Contact module (catalogue no. LRZ 914) with connector to NAMUR NE28. Functionality as LRZ 915, but only one output and one input on each of two DIN sockets.

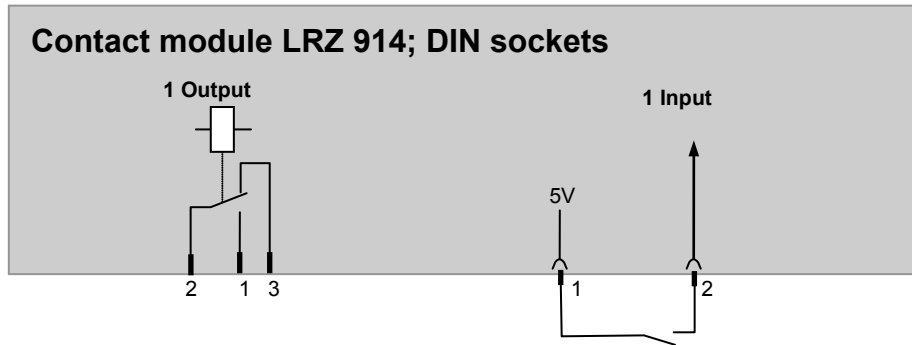

### Contact inputs and outputs:

Output	Input
<ul style="list-style-type: none"> <li>– View on flange plug (Front) or solder side coupler socket.</li> <li>– Max. 30 V; 0.2 A.</li> </ul> Coupler socket Catalogue number EQD 047.	<ul style="list-style-type: none"> <li>– View on flange plug (Front) or solder side coupler socket.</li> <li>– Signal approx. 5 V, 10 mA. Do not use pin 3!</li> </ul> Coupling plug Catalogue number EQS 048.
	1 = normally open (make) 2 = common, 3 = normally closed (break)



- Use shielded lines. Connect shielding with connector housing. Cover unused plug connections with protecting caps!



### 8.5.3 Menu structure contact module (Master)

All existing dialogue boxes are illustrated. The Master unit however masks out commands, which cannot be executed.

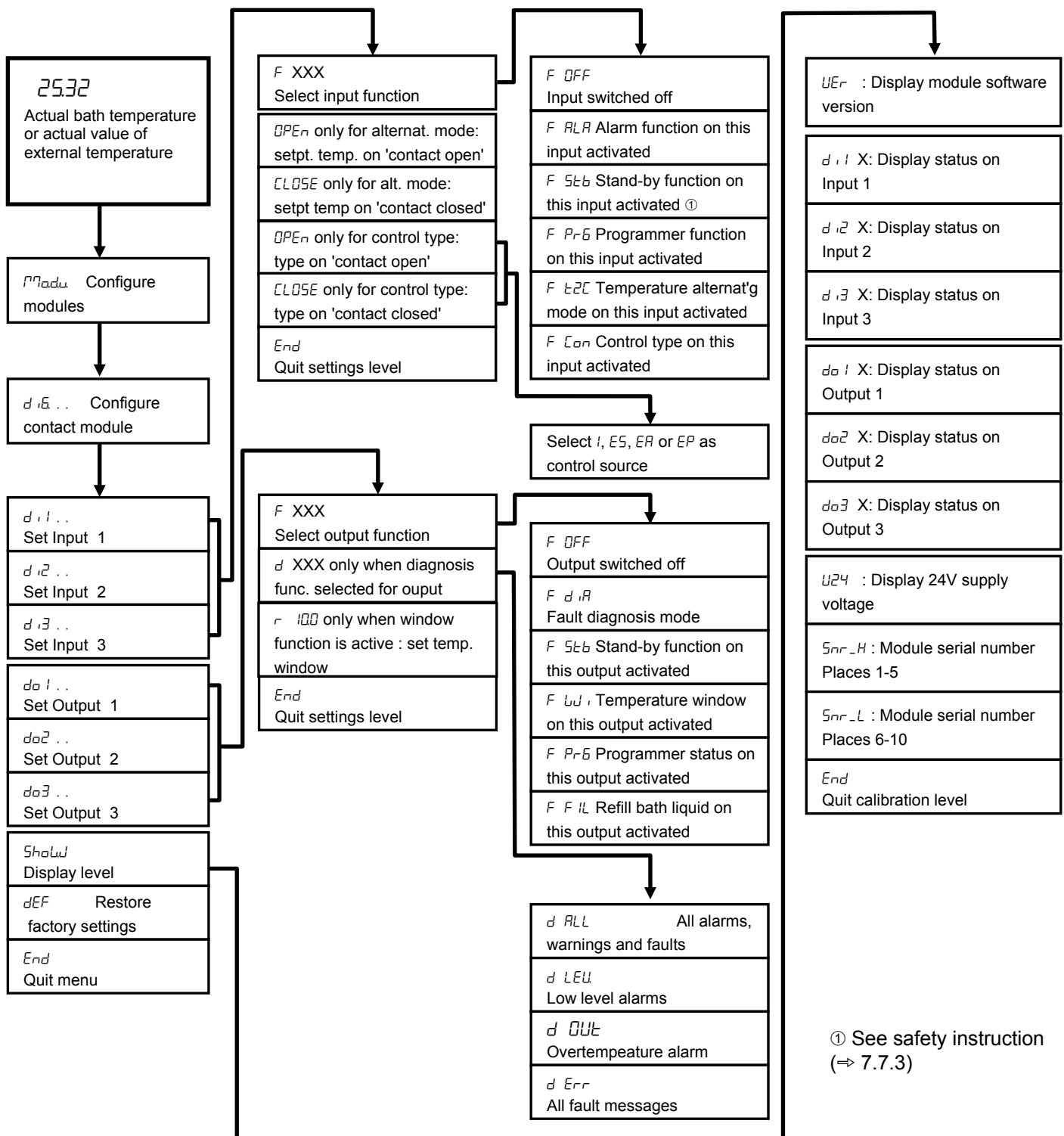

① See safety instruction  
(⇒ 7.7.3)

## 9 Maintenance

### 9.1 Cleaning



Withdraw the equipment mains plug before cleaning.

Cleaning can be carried out with water to which a few drops of surfactant (washing-up liquid) have been added and using a damp cloth.



No water must enter the control section.



Carry out appropriate decontamination if hazardous material is spilt on or in the equipment.

The cleaning or decontamination method is determined by the user's specialist knowledge. In case of doubt, contact the manufacturer.

### 9.2 Device status

The thermostat can be conveniently checked with the Command Console. Some values can however also be interrogated in the Master version.

#### 9.2.1 Interrogating the device type

→ *PFENW.* → *PARA.* → *TYPE.* (⇒ Section 7.6.4)

→ **Settings** → **Device status** → **Device type**

With low temperature thermostats, the device type is detected automatically and cannot be changed.

#### 9.2.2 Software version

→ *PFENW.* → *SHOLD* → *VER* (⇒ Section 7.6.8).

Here, only the version of the control system in the Master is displayed.

→ **Settings** → **Device status** → **Software version**.

With the Command Console the versions of the control system (**Control**), safety system (**Safety**), Command Console (**Command**), cooling system (**Cool**) and, where applicable, other connected modules are displayed.

#### 9.2.3 Serial numbers

→ *PFENW.* → *SHOLD* → *Snr H* and *Snr L* (⇒ Section 7.6.8).

Under *Snr H* the first five places of the ten-character serial number of the Master device are displayed. Under *Snr L* the last five places are shown.

→ **Settings** → **Device status** → **Serial numbers**.

With the Command Console the serial number of the Master (**Master**), Command Console (**Command**), cooling system (**Cool**) and other connected modules are displayed.

### 9.2.4 Device data

<b>Master</b>	→ <i>Prüfung</i> → <i>show</i> (⇒ Section 7.6.8)																																
	– Various device datas are displayed.																																
<b>Command</b>	<b>Device data</b>																																
<table border="1" style="width: 100%; border-collapse: collapse;"> <tr> <td>T ext Pt</td><td>25.70</td><td>T int</td><td>-8</td></tr> <tr> <td>T ext analog</td><td>---.---</td><td>Mains U(%)</td><td>100.74</td></tr> <tr> <td>T ext serial</td><td>---.---</td><td>Mains frequ.</td><td>50</td></tr> <tr> <td>T cont. head</td><td>39.80</td><td>Level</td><td>4</td></tr> <tr> <td>T heatsink</td><td>51.68</td><td>Low voltage</td><td>27.90</td></tr> <tr> <td>Pump pow.</td><td>44.90</td><td>5V supply</td><td>5.00</td></tr> <tr> <td>Pump rpm</td><td>5460</td><td>Fan voltage</td><td>7.0</td></tr> <tr> <td>Pumpe cur.</td><td>1.68</td><td>Cur. cons.</td><td>2.84</td></tr> </table>	T ext Pt	25.70	T int	-8	T ext analog	---.---	Mains U(%)	100.74	T ext serial	---.---	Mains frequ.	50	T cont. head	39.80	Level	4	T heatsink	51.68	Low voltage	27.90	Pump pow.	44.90	5V supply	5.00	Pump rpm	5460	Fan voltage	7.0	Pumpe cur.	1.68	Cur. cons.	2.84	→ <b>Settings</b> → <b>Device status</b> → <b>Device data</b> → <b>Display</b>
T ext Pt	25.70	T int	-8																														
T ext analog	---.---	Mains U(%)	100.74																														
T ext serial	---.---	Mains frequ.	50																														
T cont. head	39.80	Level	4																														
T heatsink	51.68	Low voltage	27.90																														
Pump pow.	44.90	5V supply	5.00																														
Pump rpm	5460	Fan voltage	7.0																														
Pumpe cur.	1.68	Cur. cons.	2.84																														
	<ul style="list-style-type: none"> <li>– T ext shows various actual temperatures in °C from ext. Pt100 and the modules.</li> <li>– T cont. head and T heatsink are temperatures of electronics in the Master in °C.</li> <li>– Pump power in Watts, speed in rpm, current in ampere (A).</li> <li>– T<sub>int</sub> indicates the current internal bath temperature in °C.</li> <li>– Mains voltage in percentage (%) of nominal and frequency in hertz (Hz).</li> <li>– Level indicates the liquid level in the internal bath.</li> <li>– Voltage of power transformer, 5 V supply and fan in Volt.</li> <li>– Cur. cons.: Mains current consumption in Ampere.</li> </ul>																																
<table border="1" style="width: 100%; border-collapse: collapse;"> <tr> <td>Pump</td><td>Menu</td><td>End</td><td>T<sub>set</sub></td><td>T<sub>fix</sub></td></tr> </table>	Pump	Menu	End	T <sub>set</sub>	T <sub>fix</sub>																												
Pump	Menu	End	T <sub>set</sub>	T <sub>fix</sub>																													

### 9.2.5 Fault memory (Command)

For the analysis and localization of faults the Command version includes a fault memory in which up to 45 fault and alarm messages are saved.

<b>Command</b>	<b>Error store</b>																																																						
<table border="1" style="width: 100%; border-collapse: collapse;"> <thead> <tr> <th>No.</th><th>Source</th><th>Code</th><th>Type</th><th>Date</th><th>Time</th></tr> </thead> <tbody> <tr> <td>10</td><td>Safety</td><td>2</td><td>Alarm</td><td>-----</td><td>-----</td></tr> <tr> <td>9</td><td>Safety</td><td>4</td><td>Warn.</td><td>28.08.03</td><td>15:32:02</td></tr> <tr> <td>8</td><td>Contro.</td><td>32</td><td>Error</td><td>17.07.03</td><td>10.:52:02</td></tr> <tr> <td>7</td><td>Contro.</td><td>3</td><td>Warn.</td><td>06.06.03</td><td>11:15:11</td></tr> <tr> <td>6</td><td>Contro.</td><td>9</td><td>Alarm</td><td>05.06.03</td><td>08:45:01</td></tr> <tr> <td>5</td><td>Contro.</td><td>3</td><td>Alarm</td><td>01.06.03</td><td>17:58:22</td></tr> <tr> <td>4</td><td>Contro.</td><td>4</td><td>Warn.</td><td>28.05.03</td><td>20:01:22</td></tr> <tr> <td>3</td><td>Contro.</td><td>5</td><td>Warn.</td><td>27.05.03</td><td>07:58:00</td></tr> </tbody> </table>	No.	Source	Code	Type	Date	Time	10	Safety	2	Alarm	-----	-----	9	Safety	4	Warn.	28.08.03	15:32:02	8	Contro.	32	Error	17.07.03	10.:52:02	7	Contro.	3	Warn.	06.06.03	11:15:11	6	Contro.	9	Alarm	05.06.03	08:45:01	5	Contro.	3	Alarm	01.06.03	17:58:22	4	Contro.	4	Warn.	28.05.03	20:01:22	3	Contro.	5	Warn.	27.05.03	07:58:00	→ <b>Settings</b> → <b>Device status</b> → <b>Error store</b> → <b>Display</b> .
No.	Source	Code	Type	Date	Time																																																		
10	Safety	2	Alarm	-----	-----																																																		
9	Safety	4	Warn.	28.08.03	15:32:02																																																		
8	Contro.	32	Error	17.07.03	10.:52:02																																																		
7	Contro.	3	Warn.	06.06.03	11:15:11																																																		
6	Contro.	9	Alarm	05.06.03	08:45:01																																																		
5	Contro.	3	Alarm	01.06.03	17:58:22																																																		
4	Contro.	4	Warn.	28.05.03	20:01:22																																																		
3	Contro.	5	Warn.	27.05.03	07:58:00																																																		
	<ul style="list-style-type: none"> <li>– The last message is at the top.</li> <li>– Each message line can be marked with the cursor keys. The message appears in plain text in the footer.</li> <li>– Under Source the CAN node is displayed which signaled the fault.</li> <li>– Code is the number, which in the Master is shown in the display until the cause has been rectified.</li> <li>– Type: Alarm, Warning or Fault (Error).</li> </ul>																																																						
Low level <table border="1" style="width: 100%; border-collapse: collapse;"> <tr> <td>Pump</td><td>Menu</td><td>End</td><td>T<sub>set</sub></td><td>T<sub>fix</sub></td></tr> </table>	Pump	Menu	End	T <sub>set</sub>	T <sub>fix</sub>																																																		
Pump	Menu	End	T <sub>set</sub>	T <sub>fix</sub>																																																			

### 9.3 Servicing repair and disposal information



- Withdraw the mains plug before all service and repair work.
- Only specialists must carry out repairs in the control section.
- Keep to service intervals (⇒ 9.3.2). If servicing does not occur at the stated intervals, then the manufacturer can no longer guarantee the safe operation of the thermostat.

#### 9.3.1 Servicing

LAUDA Thermostats largely require no service. If the heat transfer liquid becomes contaminated, it should be replaced (⇒ Section 6.2).



- At the back of the Proline head a main fuse switch  is located which interrupts the mains connection when an overload occurs. It is then in the "o" position and can be set in the "-" position again.
- If the fuse trips again, Service must locate the cause.
- Additionally, a safety fuse, which protects the low voltages, is situated on the mains board. If a fuse fails (→ mains lamp does not light) only replace with a fuse with the specified data (one x T (= slow-blow) 10 A, size 5 x 20 → Fuse is located in the unit as shown below).

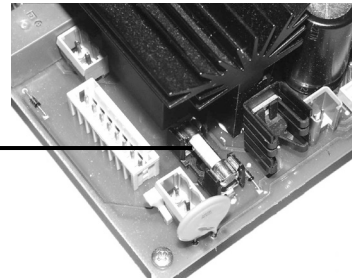
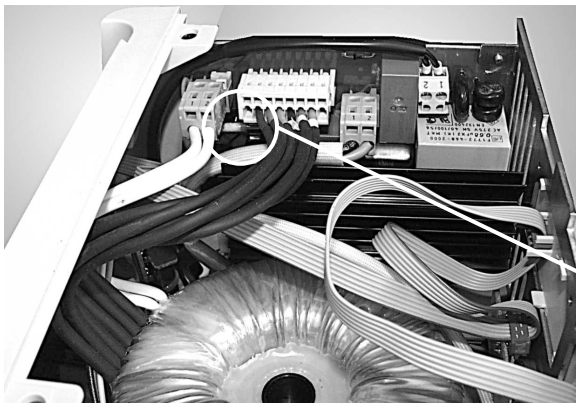

UL 533

**9.3.2 Service intervals**

System part	Mandatory for initial operation and before any longer unsupervised operation, then with recommended frequency	Comment
<b>Complete device</b>		
External condition of the device	Monthly	
<b>Heat transfer liquid</b>		
Analysis of heat transfer liquid	Half-yearly (and as required)	(⇒ 9.3.4)
<b>Bath vessel with drain tap</b>		
Sealing	Daily	External visual inspection
<b>External hoses</b>		
Material fatigue	Monthly	External visual inspection
<b>Cooling unit</b>		
Cleaning of condenser	Monthly	(⇒ 9.3.3)
<b>Electronics</b>		
Overtemperature protection	Quarterly	(⇒ 7.14.1)
Low-level protection	Quarterly	(⇒ 7.14.2)
High-level protection	Quarterly	(⇒ 7.14.3)

**9.3.3 Cleanig the condenser**



The SmartCool System refrigerating machine operates largely without servicing. So that the full cooling power is available, the condenser should be cleaned of dust at intervals of one month or longer depending on the operating period and dust level in the ambient air. To do this, open the front grille, brush off the condenser and, where necessary, blow over with compressed air.

Extreme contamination is detected by the Proline SelfCheck Assistant, which then issues a warning.

**9.3.4 Testing the heat transfer liquid**

If the heat transfer liquid becomes contaminated or degenerated, it should be renewed.

If required, the heat transfer should be checked for fitness for use (e.g. when changing the method of operation), or at least half-yearly. Further use of the heat transfer liquid is only permissible if the inspection indicates this.

The test of the thermal transfer medium should take place according to DIN 51529; Testing and assessment of used heat transfer media.  
Source: VDI 3033; DIN 51529.

**9.3.5 Repair information**

If you need to send in a unit for repair, it is essential to first contact the LAUDA Service Constant

Temperature Equipment (⇒ 9.4).



- When sending in the unit, ensure that it is carefully and properly packed. LAUDA cannot be held liable for any damage caused by improper packing.

### 9.3.6 Disposal information



The following applies to Europe: Disposal of the device may only be carried out by qualified specialists according to EC Directive 303/2008/EC in conjunction with 842/2006/EC.

The disposal is regulated by EC Directive 2002/96/EC.

### 9.3.7 Disposal of the refrigerant

The refrigeration circuit is filled with CFC-free HFC refrigerant. The type and filling quantity can be read on the unit or on the rating plate. Repair and disposal only through a qualified refrigeration engineer!

Global Warming Potentials GWP	
Refrigerant	GWP <sub>(100a)</sub> *
R-23	14800
R-404A	3922
R-508A	13214
* according to IPCC IV – time span 100 years Comparisons CO <sub>2</sub> = 1.0	

### 9.3.8 Disposal of the packaging

The following applies to Europe: The disposal of the packaging must be carried out according to the EC Directive 94/62/EC.

#### 9.4 Service, ordering replacement parts and rating label

When ordering spares please quote instrument type and serial number from the rating label. This avoids queries and supply of incorrect items.



The serial number is combined like following, for example **LCK1885-16-0001**

LCK1885	=	catalogue number,
16	=	manufacturing year 2016,
0001	=	continuous numbering.

Contact LAUDA Service Constant Temperature Equipment in the following cases:

- In the event of faults on the device
- For technical questions about the device
- For spare part orders

Contact our Sales Department for application-specific questions.

**LAUDA Service Constant Temperature Equipment**  
**Telephone: +49 (0)9343 503-350 (English and German)**  
**E-Mail [service@lauda.de](mailto:service@lauda.de)**

We are available any time for your queries and suggestions.

**LAUDA DR. R. WOBSE R GMBH & CO. KG**  
**Pfarrstraße 41/43**  
**97922 Lauda-Königshofen**  
**Germany**  
Phone: +49 (0)9343 503-0  
Fax: +49 (0)9343 503-222  
E-Mail [info@lauda.de](mailto:info@lauda.de)  
Internet <http://www.lauda.de>

### 10 Accessories

Description	Application	LAUDA Catalogue No.
LAUDA Wintherm Plus PC Program	Control of the thermostat, online display of all values as a graph with free choice of time frame. Incl. RS232 cable (2 m).	LDSM2002
RS232/485 Interface modules	Digital Communication, operation of the LAUDA PC software Wintherm Plus (⇒ 8.3)	LRZ 913
RS232 Cable (2 m)	Thermostat-PC Sub-D (9 pin. 9 pin)	EKS 037
RS232 Cable (5 m)	Thermostat-PC Sub-D (9 pin. 9 pin)	EKS 057
Analogue module	Current and voltage interface (⇒ 8.4)	LRZ 912
Relays module with 3 input and 3 output channels	Import and export of thermostat signals (⇒ 8.5.1)	LRZ 915
Relays module with 1 input and 1 output channel	NAMUR NE28 functionality (⇒ 8.5.2)	LRZ 914
T-piece adapter cable for the LAUDA internal bus (LiBus) ①	For the connection of further LiBus components (with heating thermostats two LiBus ① connections are not occupied and one with cooling thermostats)	EKS 073
Extension for LiBus ① 5 m	For LiBus ① components, but especially for remote operation with the command console	EKS 068
Extension for LiBus ① 25 m		EKS 069
Automatic refill device with LiBus ① control	Evaporating heat transfer liquid is automatically topped up	LCZ 9661
Shut-off unit with LiBus ① control.	Prevents the return of cooling liquid into the bath from external containers located above the bath	LCZ 9673
Controlled high temperature cooler, control via LiBus ①	For the rapid cooling of high bath temperatures, using water cooling.	LCZ 9663
Level controller without reverse-flow protection, mechanical function.	Keeps the liquid level in an open external bath at a constant level	LCZ 0660
Raising platform 300 mm x 200 mm for P 18, RP 1840/1845	For lowering and lifting out objects for P 18, RP 1840/1845	LCZ 0664
Raising platform 300 mm x 350 mm for P 26, RP 3530	For lowering and lifting out objects for P 26, RP 3530 (depth 250 mm).	LCZ 0665
Application frame for 56 tubes, diam. 10-13 mm, 80 mm ID②.	2 frames fit in each of P 18, RP 1840 and RP 1845; 4 frames fit in P 26.	UG 070
Application frame for 33 tubes, diam. 14-18 mm, 80 mm ID②	2 frames fit in each of P 18, RP 1840 and RP 1845; 4 frames fit in P 26.	UG 071
Application frame for 33 tubes, diam. 14-18 mm,	2 frames fit in each of P 18, RP 1840 and RP 1845; 4 frames fit in P 26.	UG 072



Description	Application	LAUDA Catalogue No.
110 mm ID <sup>②</sup>		
Application frame for 14 tubes, diam. 24-30 mm, 110 mm ID <sup>②</sup>	2 frames fit in each of P 18, RP 1840 and RP 1845; 4 frames fit in P 26.	UG 073
Application frame for 20 tubes, diam. 14-18 mm, 80mm ID <sup>②</sup> .	1 frame fits in P 8, (P 12), RP 845, RP 855, RP 870, RP 890.	UG 076
Application frame for 20 tubes, diam. 14-18 mm, 110 mm ID <sup>②</sup> .	1 frame fits in P 8, (P 12), RP 845, RP 855, RP 870, RP 890.	UG 077
Gable cover for beer forcing test, 0.3 litre bottles	For RP 3530 and P26.	LCZ 011
Gable cover for beer forcing test, 0.5 litre bottles	For RP 3530 and P26.	LCZ 058
Displacement body for 8 litre baths.	The heating and cooling rates are reduced due to the bath volume being reduced to approx. 4 litres.	LCZ 0667
Suspended basket for notched bar impact samples.	For RP 870/ RP 890.	LCZ 0658
Wall bracket for command console.	For mounting the console securely on the wall or on a laboratory stand.	LCZ 0659
Conversion kit for guide rollers with 2 stops for RP 890/ RP 1290.	For replacing the two standard production rollers by guide rollers with a brake.	LCZ 0669
Conversion kit for guide rollers with 4 stops for RP 890/ RP 1290.	For replacing the two standard production rollers and the two feet by guide rollers with a brake.	LCZ 0672
Equipment trolley for bench-top cooling thermostats	Movable on lockable castors, height adjusts from 370 mm to 455 mm, footprint 555 mm x 465 mm, holds up to 160 kg load.	LCZ 036

① LiBus = LAUDA internal BUS (based on CAN).

② ID = Immersion depth for test tubes.

We will inform you about other accessories on request (⇒ 9.4). Also, refer to our special and accessory brochures.

### 11 Technical data and diagrams

The figures have been determined according to DIN 12876.

			RP 845 RP 845C	RP 855 RP 855C	RP 870 RP 870C	RP 890 RP 890C	RP 1290 RP1290C	RP 1840 RP1840C	RP 1845 RP1845C	RP 3530 RP3530C	
Operating temp.- ACC range	°C		-45 — 200	-55 — 200	-70 — 200	-90 — 200	-88 — 200	-40 — 200	-50 — 200	-35 — 200	
Ambient temp. range	°C	5...40									
Relative humidity		maximum relative humidity 80 % for temperatures up to 31 °C, decreasing linearly to 50 % relative humidity at 40 °C									
Storage temperature range	°C	-20 — 44									
Setting resolution	°C	0.1 / 0.01 (Master); 0.01 (Command)									
Display resolution	°C	Master: 0.01 Command: 0,1 / 0,01 / 0,001									
Display accuracy		±0.2 K can be calibrated additively (⇒ 1.2 )									
Temperature stability	±K		0.01	0.01	0.02	0.02	0.02	0.01	0.01	0.02	
Heater power											
230 V; 50 Hz	kW		3.5								
115 V; 60 Hz	kW		1.75								
200 V; 50/60 Hz	kW		2.7								
100 V; 50/60 Hz	kW		1.3								
208 — 220 V; 60 Hz	kW		2.9								
Cooling power at 20 °C t <sub>amb</sub> (Pump Level 3 <sup>①</sup> ) @ bath temp.	with thermal transfer oil	200 °C	kW	1.0	1.7	0.5	0.5	0.5	1.0	1.7	1.0
	with ethanol	20 °C	kW	0.8	1.6	0.38	1.1	1.1	0.9	1.6	0.9
		0	kW	0.7	1.1	0.36	1.0	1.0	0.7	1.1	0.7
		-20 °C	kW	0.36	0.6	0.33	0.9	0.9	0.35	0.55	0.3
		-30 °C	kW	0.22	0.38	0.3	0.83	0.83	0.2	0.32	0.15
		-40 °C	kW	0.11	0.21	0.25	0.75	0.75	0.09	0.18	--
		-45 °C	kW	0.05	0.15				--	0.1	--
		-50 °C	kW	--	0.1	0.25	0.58	0.58	--	0.045	--
		-55 °C	kW	--	0.04	--	--	--	--	--	--
		-60 °C	kW	--	--	0.2	0.42	0.42	--	--	--
		-70 °C	kW	--	--	0.1	0.24	0.24	--	--	--
		-80 °C	kW	--	--	--	0.13	0.13	--	--	--
-88 °C	kW	--	--	--	0.04	0.04	--	--	--		
Refrigerant			R-404A	R-404A	R-404A & R-23	R-404A & R-508A	R-404A & R-508A	R-404A	R-404A	R-404A	
Pump type		Pressure/suction pump, 8 power levels									
Discharge pressure max.	bar	0.7 at Pump Power Level 8									
Intake suction max.	bar	0.4 at Pump Power Level 8									
Flow rate max. (pressure)	L/min	25 at Pump Power Level 8									
Flow rate max. (suction)	L/min	23 at Pump Power Level 8									
Hose connections		Thread M16 x 1; olives 13 mm external diameter									
Bath volume from — to	L		5.5 — 8			7.4 — 8.9	14.8 — 17.8	12.5 — 19		23 — 35	

		<b>RP 845 RP 845C</b>	<b>RP 855 RP 855C</b>	<b>RP 870 RP 870C</b>	<b>RP 890 RP 890C</b>	<b>RP 1290 RP1290C</b>	<b>RP 1840 RP1840C</b>	<b>RP 1845 RP1845C</b>	<b>RP 3530 RP3530C</b>
Bath opening B x L	mm	150 x 150				300 x 150	300 x 200		300 x 350
Bath depth / usable depth	mm	200 / 180							250 / 230
Height to top of bath	mm	488	570	535	535	535	488	570	540
Overall dims. B x L	mm	285 x 430	400 x 540	375 x 540	495 x 615	495 x 615	375 x 465	400 x 540	375 x 615
Overall dim. H ②	mm	688	770	735	735	735	688	770	740
Weight	kg	41	60	68	100	100	46	61	51
Power consumption 230 V; 50 Hz 115 V; 60 Hz 200 V; 50/60 Hz 100 V; 50/60 Hz 208-220 V; 60 Hz	kW kW kW kW kW	3.6 1.8 3.2 1.6 3.6							
Protection sort		IP 2 1							
Safety equipment		Class III to DIN 12876-1, FL suitable for flammable and non-flammable liquids							
Class of protection for electrical operating equipment		Protection class I according to DIN EN 61140; VDE 0140-1							
Class according to EMC-standard DIN EN 61326-1 for Canada and the USA (⇒ 1.1)		Class B Class A							

① The cooling power will be reduced by 30-35 W, when pump level 8 is chosen instead of 3.

② Put-on console Command: 56 mm higher.

**Order Numbers and mains connection data**

	<b>Mains connection data</b>	<b>RP 845 RP 845C</b>	<b>RP 855 RP 855C</b>	<b>RP 870 RP 870C</b>	<b>RP 890 RP 890C</b>	<b>RP 1290 RP1290C</b>	<b>RP 1840 RP1840C</b>	<b>RP 1845 RP1845C</b>	<b>RP 3530 RP3530C</b>
<b>Order No.: Master</b>	230 V ±10 %; 50 Hz	LCK 1885	LCK 1893	LCK 1895	LCK 1897	LCK 1899	LCK 1887	LCK 1891	LCK 1889
	115 V ±10 %; 60 Hz	LCK 4885	----	----	----	----	LCK 4887	----	LCK 4889
	200 V ±10 %; 50/60 Hz	LCK 5885	LCK 5893	LCK 5895	LCK 5897	LCK 5899	LCK 5887	LCK 5891	LCK 5889
	100 V ±10 %; 50/60 Hz	LCK 6885	----	----	----	----	LCK 6887	----	LCK 6889
	208-220 V ±10 %; 60 Hz	LCK 8885	LCK 8893	LCK 8895	LCK 8897	LCK 8899	LCK 8887	LCK 8891	LCK 8889
<b>Order No.: Command</b>	230 V ±10 %; 50 Hz	LCK 1886	LCK 1894	LCK 1896	LCK 1898	LCK 1900	LCK 1888	LCK 1892	LCK 1890
	115 V ±10 %; 60 Hz	LCK 4886	----	----	----	----	LCK 4888	----	LCK 4890
	200 V ±10 %; 50/60 Hz	LCK 5886	LCK 5894	LCK 5896	LCK 5898	LCK 5900	LCK 5888	LCK 5892	LCK 5890
	100 V ±10 %; 50/60 Hz	LCK 6886	----	----	----	----	LCK 6888	----	LCK 6890
	208-220 V ±10 %; 60 Hz	LCK 8886	LCK 8894	LCK 8896	LCK 8898	LCK 8900	LCK 8888	LCK 8892	LCK 8890

Technical modifications reserved.

### Pump characteristics measured with water

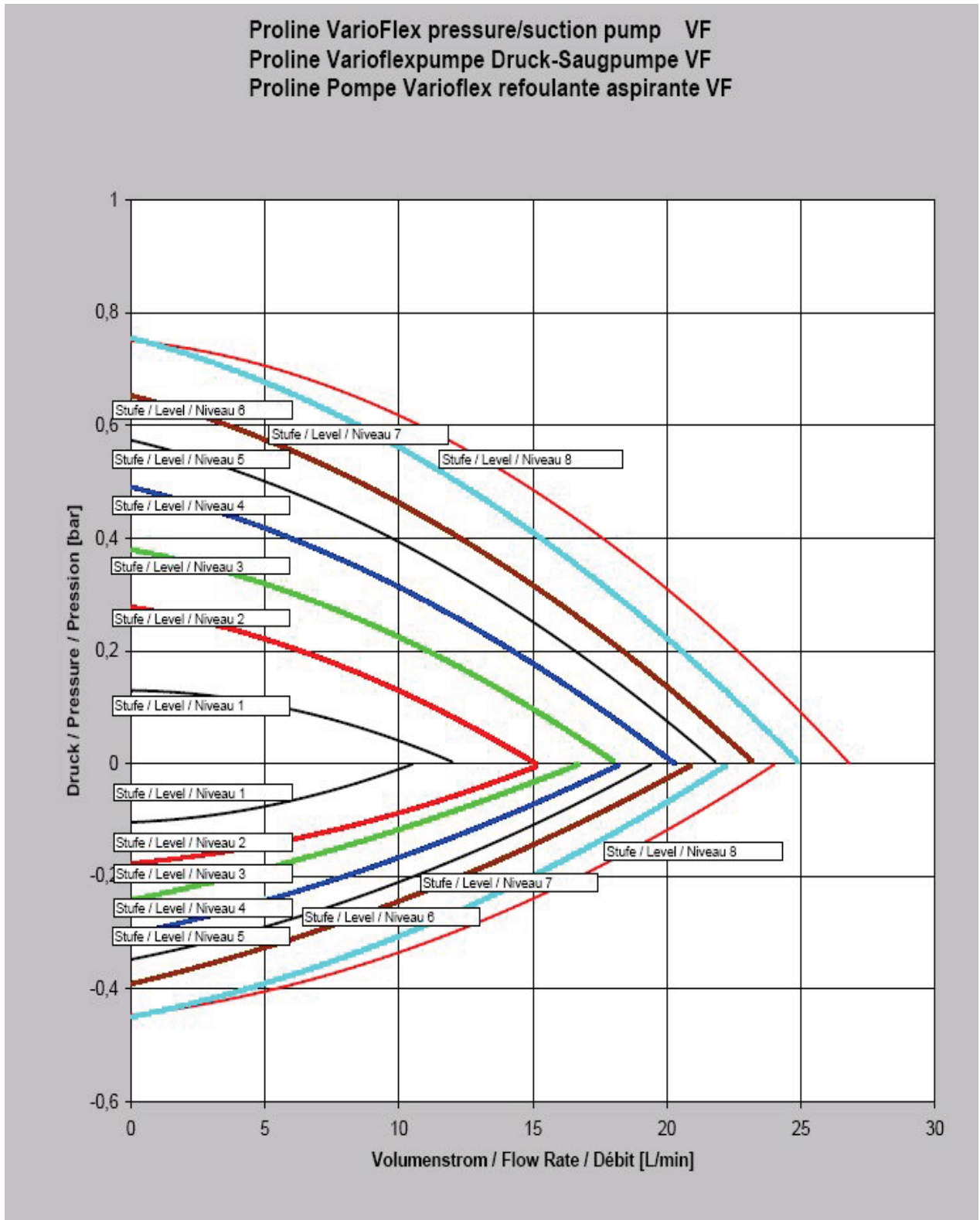

Cooling curves

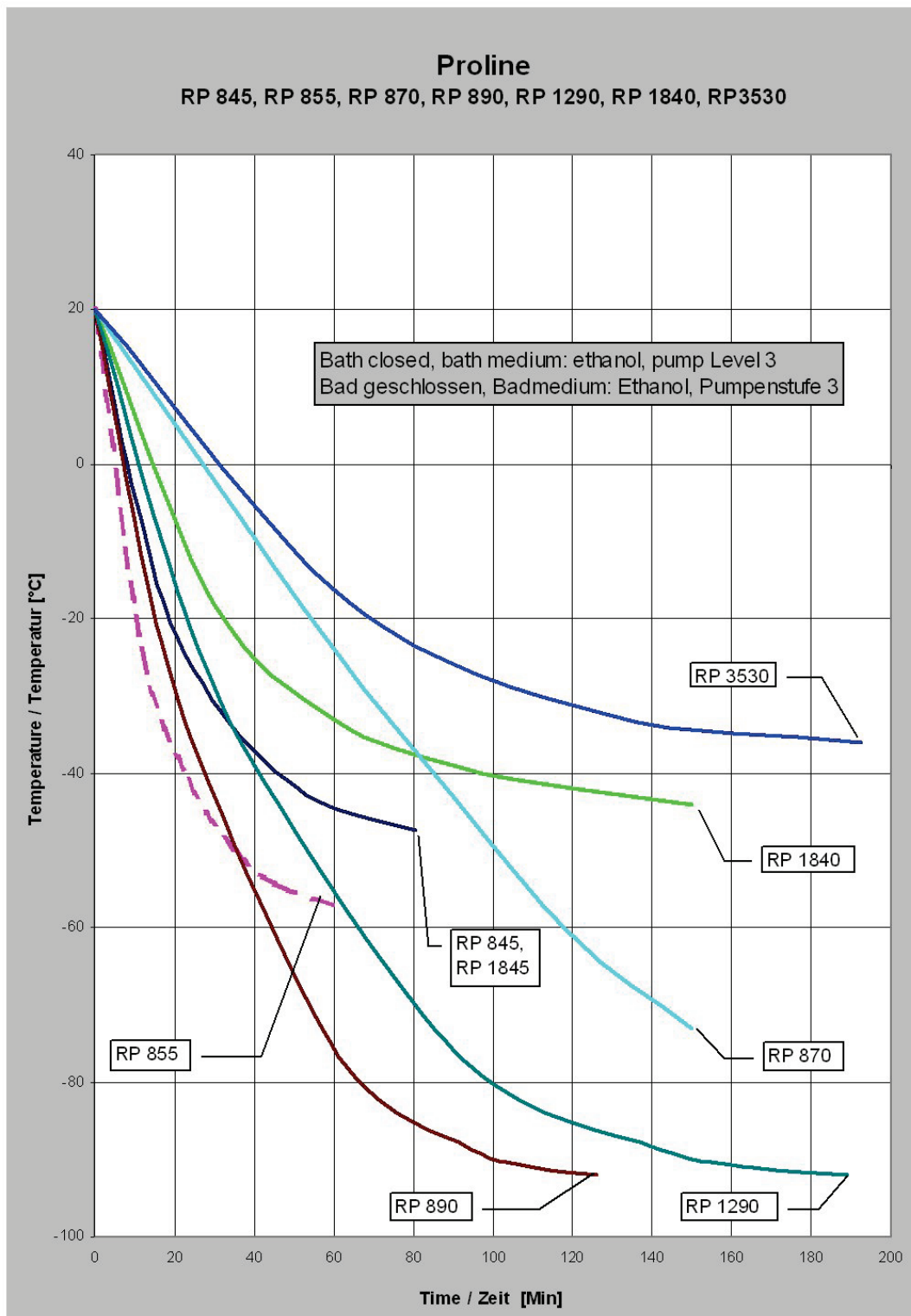

Cooling curves; Bath closed, heat transfer liquid ethanol, Pump Level 3; Time in minutes; Temperature in °C

### 12 Index

<b>A</b>		Cursor keys .....29		<b>H</b>	
Acoustic signals.....	68	<b>D</b>		Hazard sources.....	8
Activate standby.....	56	Decimal-point key.....	29	Hazards.....	8
Activating external control.....	57	dEF works settings.....	66	Heat transfer liquid	
Alarms.....	96	dEF I Offset, works setting.....	70	Selection.....	23
alternating mode.....	117	dEF E Offset, works settg.....	72	Setpoint.....	53
Ambient temperature.....	21	Delete.....	79	Testing.....	123
Analog module.....	19	<b>Device data</b> .....	121	Heat transfer oils.....	22
Analogue module.....	114	Device status.....	120	Heater rating.....	19
<i>Audio</i> acoustic signal setting.....	68	Dew formation.....	28	High-level settings.....	99
<i>Auto</i> .....	62	<b>Display data</b> .....	32	High-level warning/alarm.....	100
<b>Auto start</b> .....	62	Display resolution.....	60	Hoses.....	24
<b>B</b>		Disposal.....	22	<b>I</b>	
Basic		Disposal information.....	124	Info.....	84
<b>settings</b> .....	37	Draining.....	22	Instructed specialist personnel.....	8
window.....	30	Duo key, Command.....	29	Interface modules.....	18
Bath liquid		<b>E</b>		Internal probe control source.....	58
Viscosity.....	16	ER analog module		Interrogating device type.....	120
Bath temperature display.....	26	control source.....	58	<b>K</b>	
<i>BLDC</i> Pump blocked.....	101	<b>Edit</b> .....	79	Key for arithmetic sign.....	29
<b>Brightness</b> .....	30	EMC standard EN 61326-1		Key functions.....	28
Bypass valve.....	16	1997.....	8	<b>L</b>	
<b>C</b>		Enter key		LABVIEW.....	113
<i>CAL</i> I offset adjustment.....	69	Command.....	29	<b>Language</b> .....	27
<i>CAL</i> E Offset adjustment.....	71	Master.....	28	LED signals.....	29
Calibration, temperature probe.....	69	EP external probe		<i>LEVEL</i> Low-level alarm.....	98
Changing window.....	32	control source.....	58	Limit temperature.....	63
Cleaning.....	120	Error list.....	96	Liquid level.....	22
<b>Clock</b> .....	60, 86	Errors.....	96	Liquids, flammable.....	22
Compressor.....	19	ES serial module		Load	
<i>Con</i> control.....	57	control source.....	58	At higher position.....	25
Condensation.....	28	Escape key.....	29	External.....	55
Condenser.....	19	EXT external temperature probe..	56	Locking the keyboard.....	33
Connection		External temperature.....	55	Locking, keyboard.....	33
pump.....	17	<b>F</b>		Loops.....	83
Contact module.....	19, 117	Fault list "Alarms and Warnings" 102		Low-level alarm.....	98
<b>Contrast</b> .....	30	<b>error store</b> .....	121	<b>M</b>	
Control parameter set.....	93	Filling.....	22	Main fuse switch.....	26
Control parameters.....	88	Flammable liquids.....	22	Mains connection.....	26
<b>Control Variable</b> .....	58	<b>Format of date</b> .....	60	Mains fuse.....	19, 58
Cooling capacity.....	21	Free space.....	21	Maintenance.....	120
Cooling unit.....	19	<b>G</b>		Maximum temperature.....	63
Correction limitation.....	90	Graph.....	73, 83	Menu structure	
Create a program.....	79	Graph recorder.....	73	"Master\.....	35
<i>Cur</i> current consumption.....	59	Graphical display.....	73		
Current consumption.....	58	Graphical measurement display... 31			
<b>Current Consumption</b> .....	59				

Minimum temperature ..... 63  
*P* ..... 62  
 Modules  
   install ..... 105  
 Modules ..... 18

**N**

Nameplate ..... 26  
 Nozzles  
   outflow/inflow ..... 16

**O**

Offset adjustment ..... 69  
**Offset source** ..... 65  
 Offset, temperature probe ..... 69  
 Out 1 (Program) ..... 82  
 Overtemperature cut-off ..... 97  
 Overtemperature protection ..... 96

**P**

Pause program ..... 78  
 Power level  
   pump ..... 17  
 Pressure/suction pump ..... 16  
 Profibus Modules ..... 19  
 Program sequence ..... 83  
 Programmer ..... 75, 77  
*P<sub>U</sub>* pump power levels ..... 56  
 Pump ..... 16  
   Connector ..... 16  
   Low level ..... 101  
   outflow ..... 17  
   Program setting ..... 82  
   Unused connectors ..... 25  
**Pump Level** ..... 57  
 Pump-motor supervision  
   Dry running ..... 101  
   Overload ..... 101

**R**

Ramp ..... 75  
 Ramp function ..... 85  
 Refrigerating machine ..... 19  
 Relative setpoint ..... 64

Repair ..... 122  
 RS232 / 485 Interf. module ..... 18

**S**

5 setpoint resolution ..... 61  
*S*AFE keyboard locking ..... 33  
 Safety functions ..... 96  
 Safety information ..... 8  
 Safety notes ..... 3  
 Safety system ..... 17  
 Screen displays ..... 30  
**Screen** Graph recorder ..... 73  
 Sealing caps ..... 21  
 Segment ..... 75  
 Segment "Start" ..... 76  
 Segment time ..... 81  
 Select program ..... 77  
 Self Adaption ..... 94  
 SelfCheck Assistant ..... 17, 96  
 Self-test ..... 26  
 Serial interfaces RS232/485 ..... 107  
 Serial number ..... 125  
 Serial numbers ..... 120  
 Service contact ..... 125  
 Servicing ..... 122  
**Set date** ..... 60  
*S*ET setpoint setting ..... 53  
**Set time** ..... 60  
 Setpoint offset ..... 64  
 Setpoint resolution ..... 61  
*S*ET. . Setpoint offset ..... 64  
 Setting of numerical values ..... 28  
 Setting pump power ..... 56  
 Signs in this manual ..... 7  
 SmartCool technology ..... 19  
 Socket 10S ..... 55  
 Soft keys ..... 29  
 Software version ..... 120  
**Sounds** ..... 68  
 Spare parts ..... 125  
 Standard window ..... 30  
 Standby ..... 28  
 Standby activation ..... 29  
*S*ET Type of start mode ..... 62  
 Starting up ..... 26  
**Status** ..... 77, 78

Super window ..... 31  
 Switching off ..... 28

**T**

T end °C ..... 79  
 Technical data ..... 128  
*T*EMP Overtemperature alarm ..... 97  
 Temperature ..... 60  
   display resolution ..... 60  
   External probe ..... 55  
   Gradient ..... 55  
   Limits ..... 63  
   Setpoint setting ..... 53  
**Temperature Limits** ..... 63  
*T<sub>ext</sub>* external temperature ..... 56  
*T<sub>fix</sub>* Default setpoint temp. .... 54  
*t<sub>ih</sub>* maximum temperature ..... 63  
*t<sub>il</sub>* minimum temperature ..... 63  
 Time ..... 81  
**Timer** ..... 86  
 Timer function ..... 86  
 Tolerance (Program) ..... 81  
 Tolerance range ..... 76  
*T<sub>sel</sub>* Setpoint temperature setting . 54  
 Tv manual/auto ..... 90  
 Type designation ..... 16  
 Type of start mode ..... 61

**U**

Unlocking ..... 33

**V**

Varioflex pump ..... 16  
 Version of the software ..... 120

**W**

Warnings ..... 96  
**Weekplan** ..... 86  
 Works settings ..... 66  
*W*ARN Warning ..... 100  
*W*ARN 103 High-level warning .... 100

Blank page



**An / To / A:**

LAUDA Dr. R. Wobser • LAUDA Service Center • Fax: +49 (0) 9343 - 503-222

**Von / From / De :**

Firma / Company / Entreprise: \_\_\_\_\_

Straße / Street / Rue: \_\_\_\_\_

Ort / City / Ville: \_\_\_\_\_

Tel.: \_\_\_\_\_

Fax: \_\_\_\_\_

Betreiber / Responsible person / Personne responsable: \_\_\_\_\_

Hiermit bestätigen wir, daß nachfolgend aufgeführtes LAUDA-Gerät (Daten vom Typenschild):

We herewith confirm that the following LAUDA-equipment (see label):

Par la présente nous confirmons que l'appareil LAUDA (voir plaque signalétique):

Typ / Type / Type :	Serien-Nr. / Serial no. / No. de série:

mit folgendem Medium betrieben wurde

was used with the below mentioned media

a été utilisé avec le liquide suivant

---



---



---



---

**Darüber hinaus bestätigen wir, daß das oben aufgeführte Gerät sorgfältig gereinigt wurde, die Anschlüsse verschlossen sind, und sich weder giftige, aggressive, radioaktive noch andere gefährliche Medien in dem Gerät befinden.**

**Additionally we confirm that the above mentioned equipment has been cleaned, that all connectors are closed and that there are no poisonous, aggressive, radioactive or other dangerous media inside the equipment.**

**D'autre part, nous confirmons que l'appareil mentionné ci-dessus a été nettoyé correctement, que les tubulures sont fermées et qu'il n'y a aucun produit toxique, agressif, radioactif ou autre produit nocif ou dangereux dans la cuve.**

Stempel Seal / Cachet.	Datum Date / Date	Betreiber Responsible person / Personne responsable

Formblatt / Form / Formulaire:

Unbedenk.doc

Erstellt / published / établi:

LSC

Änd.-Stand / config-level / Version:

0.1

Datum / date:

30.10.1998

**LAUDA DR. R. WOBSE** GmbH & Co. KG

Pfarrstraße 41/43

D - 97922 Lauda-Königshofen

Internet: <http://www.lauda.de>

Tel: +49 (0)9343 / 503-0

Fax: +49 (0)9343 / 503-222

E-mail: [info@lauda.de](mailto:info@lauda.de)





LAUDA DR. R. WOBSE R GMBH & CO. KG  
P.O. Box 1251 · 97912 Lauda-Koenigshofen · Germany  
Phone: +49 9343 503-0 · Fax: +49 9343 503-222  
E-mail: [info@lauda.de](mailto:info@lauda.de) · Internet: [www.lauda.de](http://www.lauda.de)